

# Vapor Sorption Analyzer

Operator's Manual



**Decagon Devices, Inc.**

Version: June 8, 2016 — 14:00:57

**Decagon Devices, Inc.**

2365 NE Hopkins Court  
Pullman WA 99163

Phone: 509-332-5601

Fax: 509-332-5158

Website: [www.aqualab.com](http://www.aqualab.com)

Email: [support@aqualab.com](mailto:support@aqualab.com) or [sales@aqualab.com](mailto:sales@aqualab.com)

**Trademarks**

AquaLab is a registered trademark of Decagon Devices, Inc.

©2008-2016 Decagon Devices, Inc.

# Contents

<b>1</b>	<b>Introduction</b>	<b>1</b>
1.1	Customer Support . . . . .	1
1.2	About This Manual . . . . .	2
1.3	Warranty . . . . .	2
1.4	Seller's Liability . . . . .	2
<b>2</b>	<b>About the VSA</b>	<b>4</b>
2.1	Moisture Sorption Isotherms . . . . .	4
2.2	Measurement Method . . . . .	5
2.3	AquaLab Vapor Sorption Analyzer Specifications . . . . .	6
<b>3</b>	<b>Theory</b>	<b>8</b>
3.1	Moisture Sorption Isotherm Methods . . . . .	8
<b>4</b>	<b>Getting Started</b>	<b>20</b>
4.1	Instrument Setup . . . . .	21
<b>5</b>	<b>User Interface and Menus</b>	<b>25</b>
5.1	Isotherm Tab . . . . .	25
5.2	Measurement Tab . . . . .	25
5.3	Configuration Tab . . . . .	26
5.4	Data Tab . . . . .	37
<b>6</b>	<b>Cleaning and Maintenance</b>	<b>41</b>
6.1	Desiccant Cartridge Desiccant Replacement . . . . .	41
6.2	Cleaning the Testing Chamber . . . . .	45
6.3	Cleaning Procedures . . . . .	47
<b>7</b>	<b>Verification of Calibration</b>	<b>49</b>
7.1	Water Activity Verification . . . . .	49
7.2	Verification Standards . . . . .	50
7.3	When to Verify for Linear Offset . . . . .	51
7.4	Isotherm Standard Comparison . . . . .	58
<b>8</b>	<b>Running a Test</b>	<b>60</b>
8.1	Becoming Familiar with Stages . . . . .	60
8.2	Running a Moisture Sorption Isotherm Test . . . . .	60
	For the DDI method . . . . .	63

---

For the DVS Method . . . . .	65
8.3 Using DDI to investigate Glass Transition . . . . .	68
8.4 Creating a Working Isotherm Using the VSA . . . . .	68
8.5 Editing a Running Isotherm Test . . . . .	69
8.6 Running a Water Activity Test . . . . .	70
<b>9 Moisture Analysis Toolkit</b>	<b>72</b>
9.1 Configure and Start a New Test . . . . .	72
9.2 Modify a Currently Running Test . . . . .	72
9.3 Download and Export . . . . .	73
<b>10 Sample Preparation</b>	<b>74</b>
10.1 Preparing the Sample . . . . .	74
10.2 Sample Needing Special Preparation . . . . .	75
<b>11 Troubleshooting</b>	<b>77</b>
11.1 Diagnostics Screen . . . . .	91
<b>12 Support and Repair</b>	<b>95</b>
12.1 Repair Costs . . . . .	96
<b>13 Appendix A</b>	<b>97</b>
<b>14 Appendix B</b>	<b>98</b>
<b>15 Declaration of Conformity</b>	<b>99</b>
<b>16 Certificate of Traceability</b>	<b>100</b>

# 1 Introduction

The AquaLab Vapor Sorption Analyzer (VSA) is an automatic isotherm generator from the world leaders in water activity measurement. The VSA is the only automatic isotherm generator that can generate isotherms using both the Dynamic Vapor Sorption (DVS) method, which generates equilibrium isotherms, and the Dynamic Dew Point Isotherm (DDI) method, which generates dynamic isotherms. By combining both methods in one instrument, the VSA makes it possible to investigate both dynamic matrix changes due to water sorption and the kinetics of those changes. This manual details VSA operation and provides information on the capabilities of your VSA.

## 1.1 Customer Support

If you ever need assistance with your VSA, have any questions or feedback, there are several ways to contact us. Decagon has Customer Service Representatives available to speak with you Monday through Friday, between 7am and 5pm Pacific time.

*Note: If you purchased your VSA through a distributor, please contact them for assistance.*

Email:

**support@aqualab.com** or **sales@aqualab.com**

Phone:

509-332-5601

Fax:

509-332-5158

If contacting us by email or fax, please include as part of your message your instrument serial number, your name, address, phone, fax number, and a description of your problem or question.

## 1.2 About This Manual

This manual includes instructions for setting up your VSA which includes setting up an isotherm test, running a test, collecting data, and analyzing data. Please read the manual before operating the VSA to ensure your instrument performs to its full potential.

Decagon Devices Inc. provides this manual to aid the end user in understanding the basic concepts of moisture sorption isotherms, enabling them to use our instruments with confidence. We have made every effort to ensure the content of this manual is correct and scientifically sound.

## 1.3 Warranty

The VSA has a one-year warranty on parts and labor. Your warranty automatically validates upon receipt of the instrument. We contact you within the first 90 days of your purchase to see how the VSA is working for you.

## 1.4 Seller's Liability

Seller warrants new equipment of its own manufacture against defective workmanship and materials for a period of three years from the date of receipt of equipment.

*Note: We do not consider the results of ordinary wear and tear, neglect, misuse, accident and excessive deterioration due to corrosion from any cause as defects.*

The Seller's liability for defective parts shall in no event exceed the furnishing of replacement parts Freight On Board the factory where originally manufactured. Material and equipment covered hereby which is not manufactured by Seller shall be covered only by the warranty of its manufacturer. Seller shall not be liable to Buyer for loss, damage or injuries to persons (including death), or to property or things of whatsoever kind (including, but not without limitation,

loss of anticipated profits), occasioned by or arising out of the installation, operation, use, misuse, nonuse, repair, or replacement of said material and equipment, or out of the use of any method or process for which the same may be employed. The use of this equipment constitutes Buyer's acceptance of the terms set forth in this warranty. There are no understandings, representations, or warranties of any kind, express, implied, statutory or otherwise (including, but without limitation, the implied warranties of merchantability and fitness for a particular purpose), not expressly set forth herein.

## 2 About the VSA

The VSA Isotherm Generator is an automatic moisture sorption isotherm generator that can generate both dynamic and equilibrium moisture sorption isotherms.

### 2.1 Moisture Sorption Isotherms

A moisture sorption isotherm defines the relationship between water activity ( $a_w$ ) and moisture content at a given temperature. This relationship is complex and unique for each product due to different interactions (colligative, capillary, and surface effects) between the water and the solid components at different moisture contents. An increase in  $a_w$  almost always accompanies an increase in water content, but in a non-linear fashion. Moisture sorption isotherms are sigmoidal in shape for most foods, although foods that contain large amounts of sugar or small soluble molecules have a J-type isotherm curve shape.

Isotherms provide information about product quality and safety. A few uses for isotherms include:

1. Monolayer moisture content determination.
2. Determine critical water activity or moisture content.
3. Limits for crispness, hardness, and flow properties.
4. Optimize moisture contents at a safe water activity that maximizes moisture and avoids over drying.
5. Determine shelf-life and storage stability of a product.
6. Predict packaging requirements based on sorption properties of a product.
7. Determine kinetics of sorption and water vapor diffusion coefficients
8. Determine the equilibrium water activity of a mixture of dry ingredients.
9. Determine the degree of crystallinity of powders.
10. Determine the level of amorphous material in a product.
11. Determine critical water activities for phase transitions.



12. Determine the relationship between water activity and glass transition temperature.
13. Determine the relationship between water activity and crystallization.
14. Determine hysteresis levels for a product.
15. Determine the moisture sensitivity of a product.
16. Determine the equilibrium moisture content at a given water activity.
17. Allow rapid moisture content determination from water activity analysis through an isotherm curve.

## 2.2 Measurement Method

The VSA is the only automatic isotherm generator that can create isotherms using both dynamic and static methods. The VSA uses the Dynamic Dew Point Isotherm (DDI) method to produce dynamic isotherms and a controlled humidity and balance system, commonly referred to as Dynamic Vapor Sorption (DVS), to produce static or equilibrium isotherms.

The DDI method for dynamic isotherms is a water activity and gravimetric analysis method that controls neither water content nor water activity, but dries or wets the sample and measures water activity and water content during the wetting or drying process. The VSA determines water content by weighing the sample using a high precision magnetic force balance and water activity with Decagon's patented chilled-mirror dew point sensor. The VSA imposes drying of the sample by flowing dry air from a desiccant tube across the sample and wetting of the sample by saturating the air with water before it enters the chamber to flow across the sample. The VSA water reservoir mounts to the temperature controlled lower block to ensure humidity saturation and minimize temperature fluctuation.

The DVS method for static or equilibrium isotherms consists of tracking sample weight change as the sample is exposed to different controlled humidities. The sample is held at each humidity for a preset time interval or until a steady state weight change is achieved, the goal being to achieve equilibrium between the sample water activ-

ity and the controlled humidity. Customers typically choose several humidity levels to preset during the set up process. The instrument then tracks equilibrium progress at each humidity level and automatically steps to the next humidity when equilibrium requirements are achieved. Weight change versus time data is recorded allowing for determining kinetics of sorption for each humidity level. Using less stringent equilibrium settings for weight change or setting a reduced time interval at each step can speed up the isotherm test, but may give non-equilibrium results. In addition, setting smaller steps in humidity increase the data resolution of the isotherm, but at the expense of much longer test times.

The VSA is a stand-alone instrument with an integrated pump system that eliminates the need for an external gas cylinder, however you can use an external gas source if desired. The instrument consists of a case which houses the power supply, air pump, balance, temperature controlled sample chamber, sensor block, sensor and temperature control electronics, water reservoir, and desiccant supply. Setup is as simple as plugging the instrument in, installing the desiccant tubes, and filling the water reservoir. Test parameters can be set using an onboard interface or using a connected computer and VSA software package.

### 2.3 AquaLab Vapor Sorption Analyzer Specifications

Water Activity (Relative Humidity) Accuracy:  $\pm 0.005 a_w$  (0.5% RH)  
(for volatiles setting,  $\pm 0.02 a_w$ , 2% RH)

Water Activity (Relative Humidity) Resolution:  $0.0001 a_w$  (0.01% RH);  $\pm 0.001 a_w$  (0.1% RH) for volatiles setting

Water Activity (Relative Humidity) Range: 0.03 to  $0.95 a_w$  (3% to 95% RH)

Water Activity (Relative Humidity) Repeatability:  $\pm 0.003 a_w$  (0.3% RH) (for volatiles setting,  $\pm 0.02 a_w$ , 2% RH)

Operating Environment: 4 to 50 °C; 0 to 90% Relative Humidity (Non-Condensing)

Sample Weight Range: 500 to 5000 mg

Sample Temperature Control Range: 15 to 60 °C at STP

Sample Temperature Stability:  $\pm 1^{\circ}\text{C}$

External Gas: 7 PSI max, if required

Mass Resolution: 0.5 mg

Sample Dish Volume: 7.5 ml recommended; 15 ml full

Water Reservoir: 20 ml

Program Identification: Alphanumeric and programmable to display product name, lot and ID number

Data Storage: 1 test

Data Communications: USB

Display: 64 x 128 Graphical display with backlighting

Case Dimensions (Footprint): 38.1 x 26.7 x 30.5 cm (15 x 10.5 x 12 in)

Case Material: Machined aluminum frame; polyurethane plastic with fire retardant

Weight: 33 pounds

Universal Power: 110 V to 220 VAC. 50/60 Hz

Operating Environment: 4 to 50 °C; 0 to 90% Relative Humidity (Non Condensing)

Certifications: CE

Warranty: One year parts and labor

## 3 Theory

Water profoundly influences product attributes such as quality and safety. To completely understand water relations in a product requires an understanding of the amount of water (moisture content) that can be held at a given energy state (water activity). Moisture sorption isotherms describe the relationship between water activity and moisture content at a constant temperature. The nature of this relationship depends on the interaction between water and other ingredients.

The amount of water vapor that a product has depends on the chemical composition, physical-chemical state, and physical structure of the product. Consequently, the isotherm shape is unique to each product type due to differences in capillary, surface, and colligative effects. (Figure 1) Products that lie in the low water activity portion of the isotherm are often referred to as dry, those in the range of 0.60  $a_w$  to 0.90  $a_w$  are intermediate moisture products, and those having water activities higher than 0.90 are high water activity products.

For ease of interpretation, isotherms are often identified by Brunauer classifications (Brunauer, 1945). Most food and pharmaceutical products fall under type I, II, or III. Type I isotherms are typical of very hygroscopic materials. Type II (sigmoidal) isotherms are typical for intermediate moisture products. Type III (J-shaped) isotherms are typical for crystalline and coated materials. These general classifications proved useful when isotherms on every product was not feasible due to time and labor constraints. However, with automation and improved speed, isotherms can easily be conducted on any product and the uniqueness of each isotherm often proves more valuable than placing them in a common classification.

### 3.1 Moisture Sorption Isotherm Methods

Constructing an isotherm consists of collecting water activity and moisture content data at various points along the water activity range. The range of water activities you use often depends on the situation, but normally run from 0.10  $a_w$  up to 0.90  $a_w$ . You can run

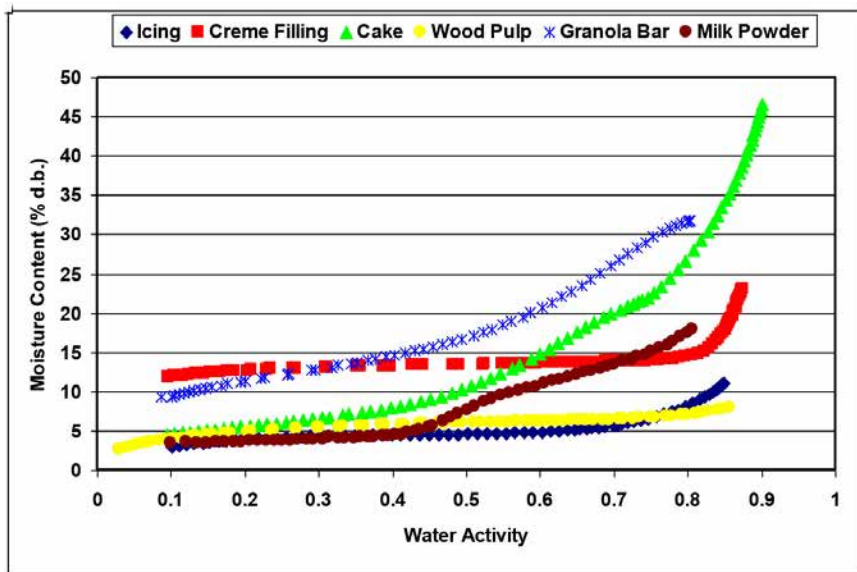

Figure 1: Moisture Adsorption Isotherms

the range of  $a_w$  by controlling water activity levels using saturated salt slurries or mechanical humidifiers and determining equilibrium moisture content at each water activity level. Equilibrium is assumed when the weight of the sample stops changing. This process is often accomplished using sealed chambers such as desiccators and the equilibration process can take weeks. There are several additional challenges to executing this manual method. Tracking the weight of the samples can be difficult. Also when removing the samples for weighing, you potentially expose them to ambient humidity, and at high humidities there is the possibility of mold growth. The Decagon VSA Isotherm Generator uses the DVS method described above to speed up and automate the construction of equilibrium isotherms, eliminating the challenges of manual determination. In addition to equilibrium moisture contents at a given water activity, equilibrium isotherms provide information about kinetics of sorption and water vapor diffusion properties.

Moisture sorption isotherms can also be determined using dynamic methods such as the DDI method used by the VSA. The DDI method

directly measures water activity while gravimetrically tracking weight, so there is no dependence on equilibration to known water activity levels to determine water activity. Adsorption occurs as saturated wet air passes over the sample. Desorption happens as desiccated air passes over the sample. After a short period of time, the VSA halts airflow and takes a snapshot of the sorption process by directly measuring the water activity and weight. The advantages of this method include: increased analysis speed as the sample does not have to wait for equilibration to a known water activity and an unmatched level of resolution. This makes it possible for dynamic isotherms to produce high resolution isotherms in a matter of days instead of the weeks it would take to make a comparable isotherm using equilibrium techniques. The high resolution of dynamic isotherms makes them valuable for observing sudden changes in sorption properties associated with matrix changes such as glass transition.

The dynamic nature of the DDI method means that moisture contents may or may not be at equilibrium and it is possible for there to be differences between dynamic and equilibrium isotherms. For samples with fast vapor diffusion, penetration by water vapor into the whole sample is rapid and isotherms using the DDI method for these types of products are comparable to equilibrium methods. However, for samples with slow diffusion rates, moisture movement through the sample is slow and complete diffusion of moisture into and out of the sample may be slow enough to give the appearance of vapor equilibrium in the headspace during water activity analysis. In reality, the moisture has not had time to be completely absorbed by the sample. Isotherms for these types of samples developed using the DDI method may have lower moisture contents during adsorption and higher moisture contents during desorption than equilibrium isotherms, resulting in higher levels of apparent hysteresis.

### **Combining DVS and DDI in One Instrument**

A unique and important feature of the AquaLab VSA is that it can generate both dynamic and equilibrium isotherms. As explained above, both DVS and DDI methods have advantages and disadvantages. While the data they generate agrees in some cases, it

is the uniqueness of the results from each method that gives them value. There is information that can only be obtained from dynamic isotherms such as critical water activities for glass transition. Similarly, there is information that can only be obtained by equilibrium isotherms such as kinetics of sorption. Therefore, to provide the most information about the moisture characteristics of a material, both types of isotherms are needed. The VSA can provide both DVS and DDI isotherms and even run them both on one sample.

## Hysteresis

Figure 2 shows two isotherms, one obtained by wetting a sample from complete dryness and the other obtained by drying a sample from saturation. The arrows show the direction of the process. The water content at each water activity is higher during desorption (drying from high water content) than adsorption (wetting from low water content). This phenomenon is called hysteresis. The curves in Figure 2 represent limits or boundary isotherms since they begin at water activities near zero and one. If a drying process reduces the water activity of a sample only part way to dryness, and the sample is then wet again, it follows a path between the wetting and drying boundary curves, as shown in Figure 3. These curves are called scanning curves, and there can be an infinite number of them depending on where drying stops and starts.

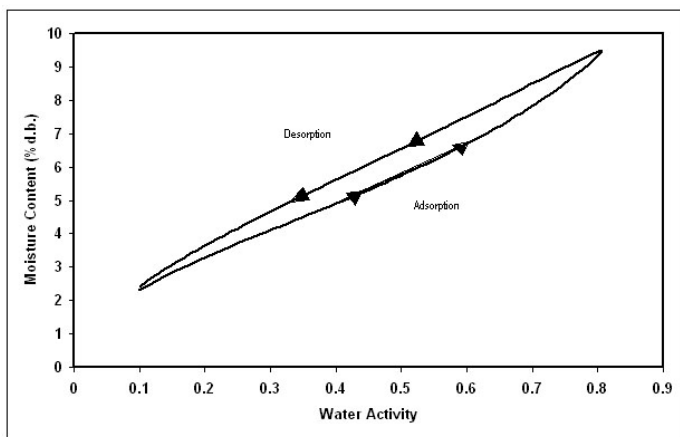

Figure 2: Full Isotherm Showing Hysteresis

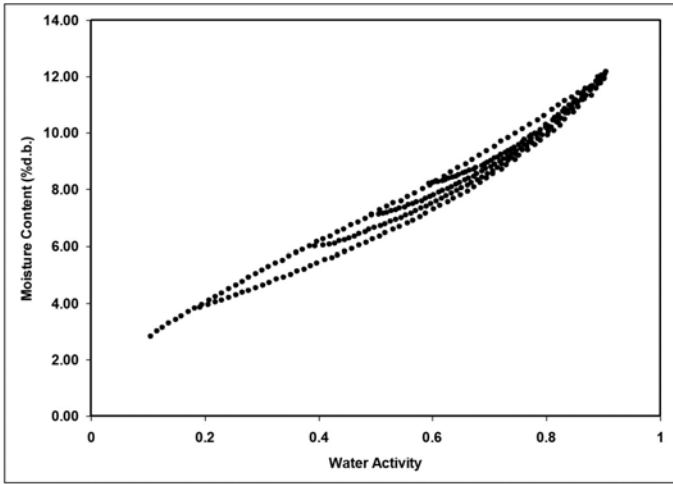

Figure 3: Scanning Adsorption Curves From Drying to Varying  $a_w$

These observations help clarify the point that an isotherm is not a single valued function. The water content for any given water activity value depends on the wetting and drying history of the sample.

It is possible to obtain isotherm data which appears to show hysteresis by failing to allow a sample to equilibrate at each step, or by inducing changes in the water binding properties of the matrix by wetting or drying. We prefer to treat these cases separately, and reserve the term hysteresis for situations where equilibrium is reached, but water contents of wetted and dried samples still differ because of their history.

There are four primary models for hysteresis. These theories emphasize; capillary condensation of porous solids, phase changes of non-porous solids, structural changes within a solid matrix, and supersaturation of some solutes during desorption. Depending on the composition of the sample, these theories explain why the water content of a desorption process is greater than that for a wetting process.

1. The “ink bottle” model illustrates the capillary condensation of porous solids theory, in which pores and capillaries fill and empty differently. Such a pore fills when the water activity



corresponding to the energy state of the larger radius is exceeded, but empties only when the water activity drops below the energy state of the narrow neck radius.

2. A phase change of non-porous solids is illustrated by the fact that desorption from rubbery state can reach equilibrium faster due to increased molecular mobility, while adsorption into a glassy material can be slow due to restrictions in molecular mobility.
3. Structural changes within a solid matrix occur when the material swells and polar sites once obscured are now exposed to bind with water. For example, hydrated protein contains many sites for water “binding” before desorption while dehydrated protein has limited polar sites for water binding prior to adsorption.
4. Some solutes may supersaturate below their crystallization water activity (non-equilibrium condition) and thus, hold more water as  $a_w$  declines. Foods with high sugar content frequently exhibit this phenomenon.

## Non-Equilibrium

If diffusion of water into (adsorption) or out of (desorption) a material is slow and you do not allow sufficient time for complete diffusion, then there is probably a large amount of apparent hysteresis that you can reduce by allowing sample equilibration.

## Matrix Changes

Figure 4 shows three different isotherm curves for spray-dried milk powder, each with unique maximum water activities and different sorption histories. The moisture sorption isotherms for spray-dried milk powder show a change in hysteresis due to a phase change at  $0.43 a_w$ . When the isotherm ends prior to the phase change at  $0.43 a_w$  (red square), there is little hysteresis. When the isotherm ends above the phase change (blue diamond), there is apparent, but not actual hysteresis due to the phase change. Subsequent isotherms run on

the sample after experiencing a phase transition (green triangle) do not show an inflection point, are repeatable, and exhibit only small levels of hysteresis. The boundary isotherm with a 0.80  $a_w$  maximum experienced a phase change at 0.43  $a_w$ , indicated by a sharp inflection point in the curve. The desorption curve for this isotherm appears to show hysteresis, especially below 0.60  $a_w$ . However, an isotherm, run on a sample wetted to a maximum water activity below the phase change, exhibits very little hysteresis. The lack of hysteresis in this isotherm indicates that the matrix changes that occur at 0.43  $a_w$  are completely responsible for the apparent hysteresis.

Various bonding mechanisms bind water in a sample to particle surfaces. When the configuration of particle surfaces changes due to a phase change, binding sites change and the amount of water which can be bound at a given energy of water also changes. An isotherm curve of the phase changed sample does not show further phase transitions since simply drying the sample does not return it to an amorphous state.

These matrix changes represent a true physical change in the material. They are not reversible by drying, no matter how many drying cycles occur. Differences between the adsorption and desorption curves in the initial isotherm is not true hysteresis since the sample matrix has experienced a physical change. Differences between sorption curves in the subsequent isotherms represent true hysteresis.

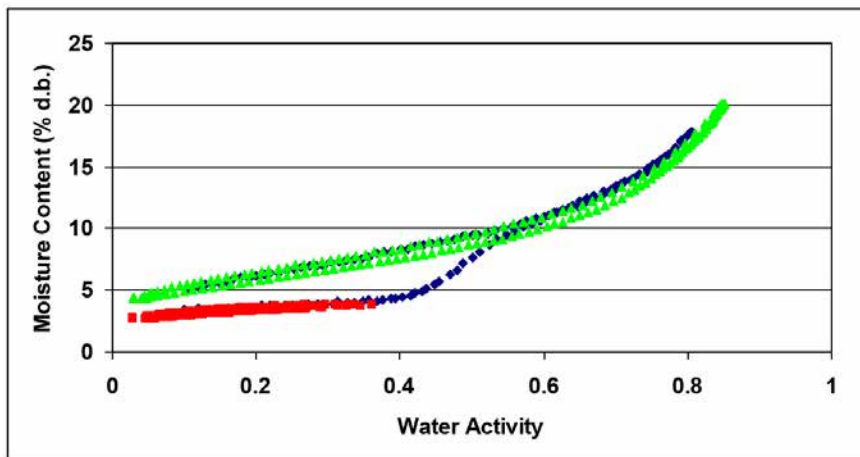

Figure 4: Spray-Dried Milk Moisture Sorption Isotherms

## Working Isotherms

Full boundary isotherms give information about the physical characteristics of a product, show hysteresis, and are important in establishing critical control points, but in many cases a working isotherm proves very useful. A working isotherm shows how a product adsorbs and desorbs water from its current or typical condition. To create a working isotherm, process the product as usual, and then create a scanning curve by wetting one sample from that point and drying a different sample from that same point. Figure 5 shows a working isotherm (blue diamond) superimposed over a full isotherm (red square) for wood pulp. There is a transition from the native starting point ( $0.60 a_w$ ) on the working isotherm in both adsorption and desorption until the curves meet the bounding adsorption and desorption curves of the full isotherm at which point the working isotherm follows the full isotherm.

The scanning curve the product initially follows depends on whether the product was previously wetted or dried to its current state. If you wet a product to a certain water activity and then dry it back down, there is an initial transition period as the product moves from the adsorption curve to the desorption curve. The same is true for a

product that you previously dried and then wetted up. There is an initial transition period as the product moves from the desorption curve to the adsorption curve. You can observe this transition region at any point on the isotherm if you change the direction of the sorption and the product exhibits hysteresis. (Figure 5)

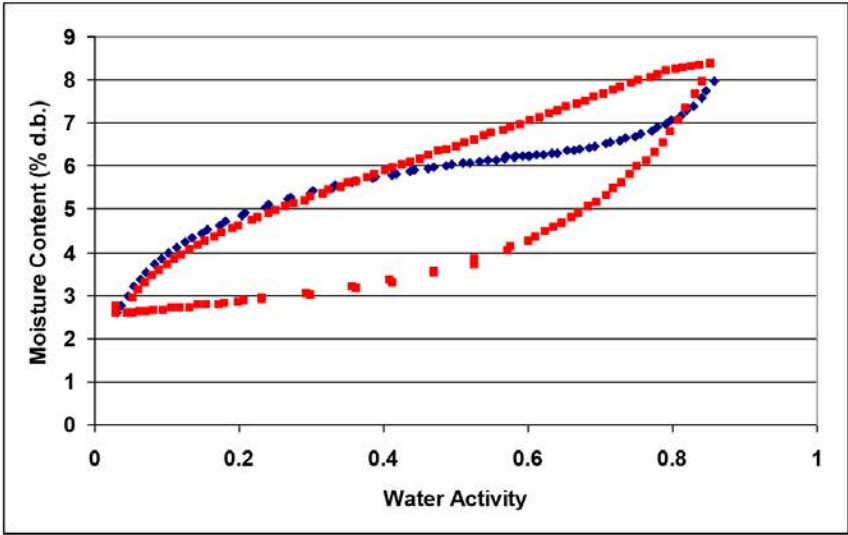

Figure 5: Working and Full Isotherm for Wood Pulp

*Note: Please refer to Section 8.4 for information about running a working isotherm using the VSA.*

## Isotherm Models

Several different isotherm models have been proposed and compared in the literature. These models are necessary to predict the moisture content at a given water activity and are used to evaluate thermodynamic functions of water in foods. The models are necessary when using isotherm methods with low data resolution to interpolate between isotherm data points. While there are 270 proposed isotherm models, the most commonly used models are the Guggenheim-Andersen-de Boer (GAB) and Brunauer-Emmett-Teller (BET). Since the BET model is only applicable up to 0.50  $a_w$ , the GAB model is widely

accepted as the most useful for characterizing isotherms across the entire water activity range. Its coefficients also have theoretical physical meaning such as providing monolayer moisture content. A new empirical model called the Double Log Polynomial (DLP) or Chi plot has proven to be even better than the GAB at characterizing complex isotherms. The model equations are shown below.

$$\text{BET} \quad m = \frac{a_w m_o c}{(1 - a_w)[1 + a_w(c - 1)]}$$

Where  $m$  is the moisture in g/100 solids or g/g solids at water activity  $a_w$  and  $m_o$  is the monolayer value in the same units. Calculate the constant  $c$  with:

$$c = \exp \frac{Q_s}{RT}$$

Where  $Q_s$  is the surface interaction energy in J/mole,  $R$  is the gas constant (8.314 J/mol K) and  $T(K)$  is the temperature.

$$\text{GAB} \quad m = \frac{m_o k_b c a_w}{(1 - k_{baa})(1 - k_b a_w + k_b c a_w)}$$

Where  $m$  is the moisture in g/100 solids or g/g solids,  $k_b$  is a constant in the range of 0.70 to 1 and  $c$  is a constant in the range of 1 to 2000. In addition,  $m_o$  is the monolayer moisture content in the same units as  $m$  and  $a_w$  is the water activity at moisture  $m$ .

$$\text{DLP} \quad m = b_3 \chi^3 + b_2 \chi^2 + b_1 \chi + b_0$$

Where  $m$  is the moisture in g/100 solids or g/g solids,  $\chi = \ln[-\ln(a_w)]$  and  $b_0 - b_3$  are empirical constants.

## Uses for Moisture Sorption Isotherms

Moisture sorption isotherms provide valuable information. For anyone who dries or wets their product, the sorption isotherm serves as a drying and wetting curve that provides information about the moisture content of a product when dried or wetted to a specific water activity. Customers can use the sorption isotherm to assist in process control by determining drying rates and optimal endpoints. If a product exhibits hysteresis, the isotherm shows what impact the hysteresis has on the moisture content after drying to a given water

activity.

An additional function of the isotherm is moisture content prediction. Although water activity is a much better predictor of safety and quality than moisture content, there are times when it is necessary to know both water activity and moisture content as well as the relationship between the two parameters for a given product. Water content measurements can be inaccurate, time-consuming and require a precision balance. As an alternative to moisture content measurement methods, you can use the sorption isotherm to determine moisture content based on water activity, usually with better precision than actually running a moisture content analysis and in much less time.

Customers can utilize isotherms to determine the effect of temperature on water activity and moisture content readings. Isotherms conducted at several different temperatures show the temperature at which a product, in a sealed package (at constant moisture content), is at unstable water activity levels.

Isotherms can be very valuable for formulation and product development. By comparing the isotherms of different formulations, it is possible to determine if a product can be adjusted to allow higher moisture content at a given water activity or a lower water activity at a given moisture content. The result can be a moister product that is still shelf stable. For those producing multi-component products, it is possible using the isotherms of the two components to determine the final water activity of the mixture without actually making the product. For dried products, the isotherm predicts the moisture content of the product when it is dried to a shelf stable water activity level.

Finally, sorption isotherms are valuable for shelf life prediction. You can use the product isotherm to determine package requirements depending on the products sensitivity to moisture or to determine the monolayer moisture content, which represents the most stable state of your product. The shape of the isotherm can provide information about the level of amorphous to crystalline material in a product.

Changes in the slope of the isotherm indicate phase transitions and can provide information about critical water activities for maintaining texture properties and preventing caking and clumping. You can also determine the water activity value where the glass transition temperature equals storage temperature or the crystallization temperature equals storage temperature.

## 4 Getting Started

### Components of VSA

The VSA requires a computer and software to generate and analyze isotherm data. You can disconnect and connect the computer once you begin a test without losing any data. Your VSA ships with these items.

- The VSA Isotherm Generator main unit
- Operator's Manual
- Quick Start Guide
- Calibration certificate / SDS certificates
- Power cord
- USB interface cable
- Two stainless steel sample cups
- Three refillable desiccant tubes
- One Decagon cleaning kit
- Two water bottles
- Three vials each of the following verification solution:
  - 0.250  $a_w$  13.41 mol/kg LiCl
  - 0.500  $a_w$  8.57 mol/kg LiCl
  - 0.760  $a_w$  6.00 mol/kg NaCl
  - 0.920  $a_w$  2.33 mol/kg NaCl
- Moisture Analysis Toolkit Software Package with Registration Key
- One 2 g NIST traceable weight
- Tweezers

*Note: Please keep your original instrument shipping box. If you ever need to return your VSA, you must ship it in the original packaging.*



## 4.1 Instrument Setup

1. Place AquaLab VSA on a flat and stable surface. Use the bubble level (Figure 6) and the adjustable feet to level the instrument. The small rubber feet on the back of the lower plate prevent tip-over and do not need to be touching the table.
2. Use AquaLab VSA where environmental temperature and humidity remain stable and are non-condensing. (See Appendix B)
3. Plug in AquaLab VSA and turn on the power (switch in back). For best results, let the instrument warm-up for two hours before use.

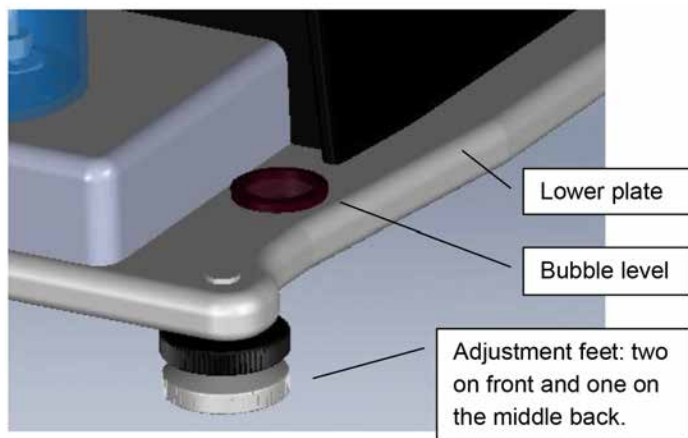

Figure 6: Adjustment and Bubble Level

4. Install the two desiccant tubes in the front of the instrument. Figure 7 shows the proper method of installing desiccant tubes. Before insertion, make sure to firmly seal the desiccant tube lid onto the desiccant tube and remove the black vinyl covers from the air fittings. Lift the desiccant tube into the area above the desiccant receiver and then insert the fittings into the mating holes. Be sure to place the black fitting into the corresponding black hole. Once in place, the desiccant tube is sealed for flow purposes even if it may feel loose.

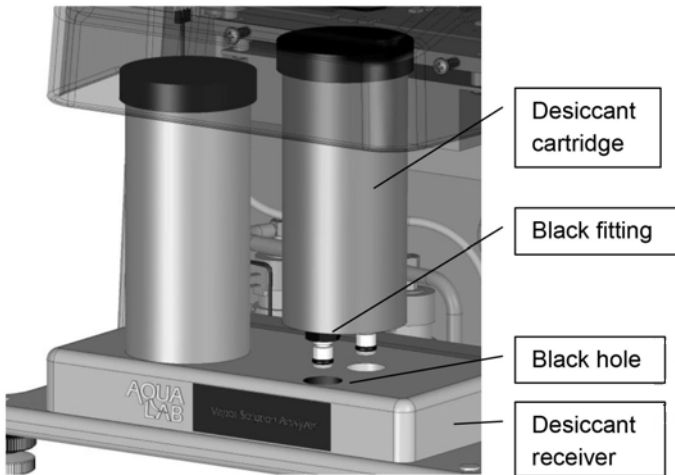

Figure 7: Desiccant Installation

5. Install the air cylinder and weighing pan. With the lid open, insert the air cylinder and weighing pan into the testing block as shown in Figure 8. These parts should remain in the instrument continually and are only to be removed for maintenance. Do not insert a sample cup unless you are running a test. Place the air cylinder into the base block bore. It should slide into the block easily and settle at the bottom of the bore. The weigh pan connects to the scale and holds the sample cup. For best results, verify cleanliness of all parts and avoid dropping the parts as damaged parts may not slide properly and affect performance.
6. Verify shipping did not damage the scale performance and test scale stability:
  - (a) Turn on the VSA and wait for it to warm up.

*Note: The scale takes about two hours after power up to come to full equilibrium.*

- (b) Go to the Configuration menu, navigate to the Diagnostics screen and press the left arrow or Enter button.

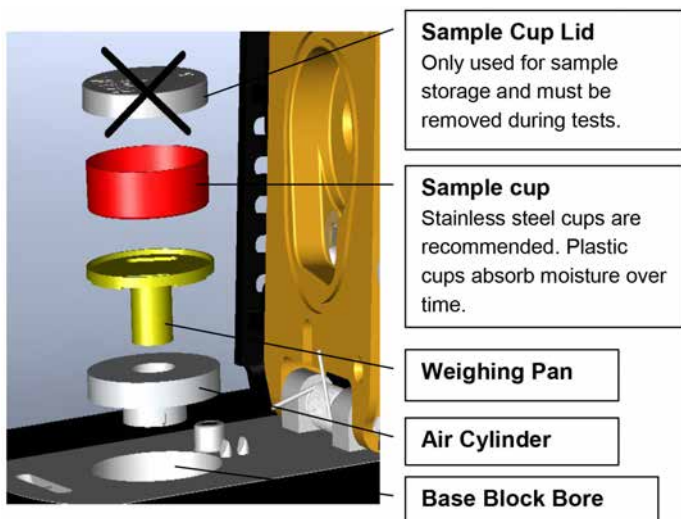

Figure 8: Sample Cup and Lower Block Assembly

- (c) Scroll down, highlight Diagnostics and press the Enter button.
  - (d) Scroll down to the screen that shows the weight. Readings should vary no more than 0.5 mg, once the scale has stabilized.
  - (e) Lightly tap the table with one finger. If the readings vary more than 0.5 mg after tapping, the table holding the VSA is probably too unstable for accurate weight readings during a test. You need to make the table more rigid or find another location for this equipment. Contact your AquaLab distributor if the scale readings are unstable after placing the unit on a stable structure.
7. Fill the water tank. Remove the black plug on the clear plastic tank fill extension located on the back right of the VSA. (Figure 9). Fill the tank with United States Pharmacopeia (USP) purified water until full to top. Reinstall the black plug once finished. The black plug should be hand tightened only.
  8. Figure 9 shows the location of a filter that you must remove and blow out from time to time when dust builds up on it. The housing around the filter is a snap on housing that you

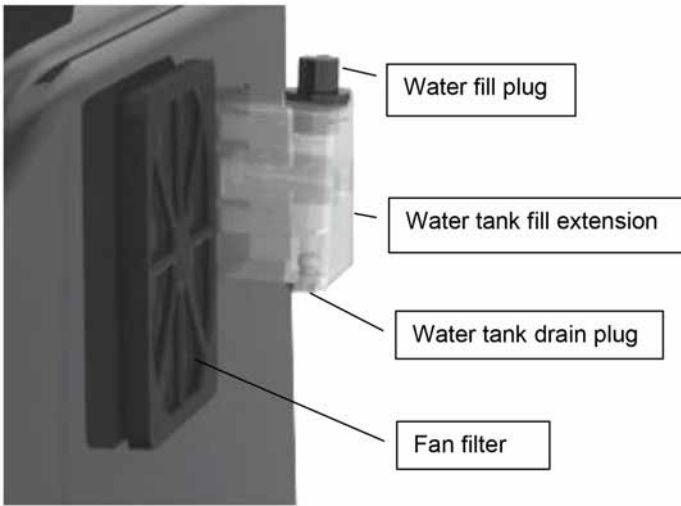

Figure 9: Tank Fill Extension

can easily remove.

9. Use the water tank drain plug to remove the water from the water tank.

*Note: Have a receptical ready to catch the water flow.*

## 5 User Interface and Menus

The AquaLab VSA is a stand-alone instrument with arrows and three buttons useful for navigating menus and beginning tests. There are four tabs at the top of the display screen, the Isotherm, Measurement, Configuration, and Data tabs. These tabs indicate the four menus you can access. To change between the tabs press the right most button below the Menu icon. The Enter icon is the Read or Enter button.

### 5.1 Isotherm Tab

The Isotherm tab is the main screen and displays each time you turn on your VSA. If the Isotherm tab screen does not appear, refer to Section 11 for troubleshooting. Operators can initiate a new test from this screen by pressing the wizard icon (third button from right). If a test is already running, this screen displays the latest test values including water activity, weight or % moisture content and temperature. Pressing the second button activates the chart view.



### 5.2 Measurement Tab

The Measurement tab allows you to take water activity readings of the sample in the sample chamber when not running a test. Pushing the right or left arrow keys changes the display to a temperature equilibration screen that shows the temperature difference between the sample temperature and the lid temperature.

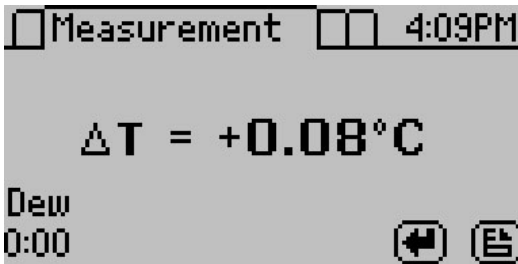
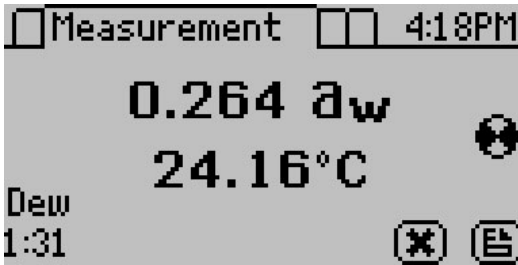

### 5.3 Configuration Tab

The Configuration tab allows the operator to view various configuration options. Pressing the up and down arrows moves through the configuration options, while pressing the right and left arrows allow the operator to page through the options.

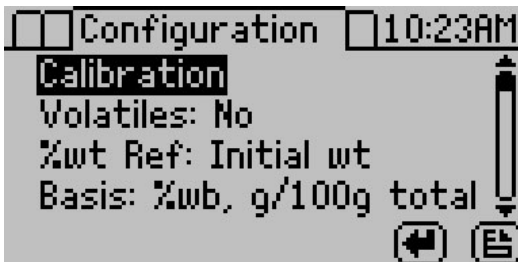

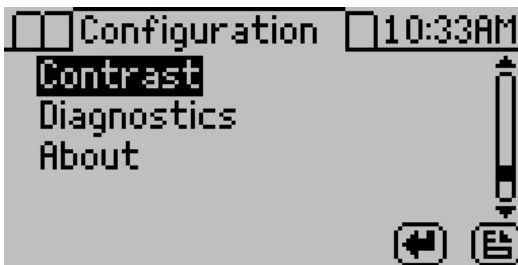
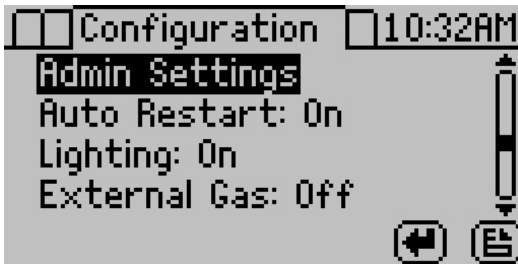
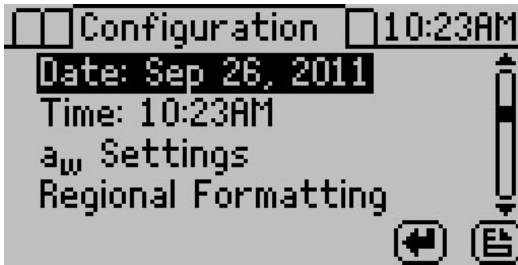

## Calibration

Highlight “Calibration” and press the Enter button to open the Calibration menu where you can make either a water activity or weight adjustment.

For more details on weight and water activity calibration procedures refer to Section 7: Verification of Calibration. You may also reset the calibration to the factory defaults by highlighting the Defaults option in the calibration menu and pressing Enter.

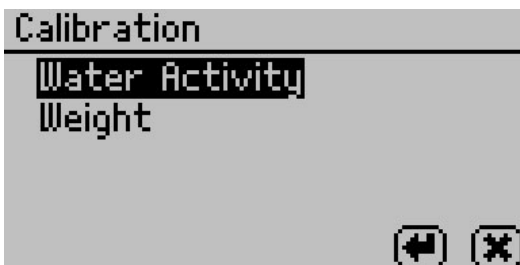

## Volatiles

The instrument gives accurate readings on most samples when the default volatiles setting is “Off.” When reading with volatiles off the chilled mirror method is used by default. However, samples with certain volatiles in high enough concentrations may give inaccurate water activity values. This is because the volatiles condense on the mirror during the reading process, but do not evaporate from the mirror as water does. The concentration of volatiles that causes interference is variable and matrix dependent.

The most effective method to determine if volatiles are a problem is to compare dew point readings to capacitance readings. If the dew point readings are more than 0.02 higher than the capacitance readings, volatiles are likely a problem and it is recommended that the volatiles setting be switched to On. When you turn the volatiles setting on, the instrument only uses the capacitive relative humidity sensor for water activities measurements and isotherm tests. All other operations and features are the same, including measurement times and adjusting for linear offset. Press Enter to toggle the volatiles setting on and off.

## Weight Reference

Weight reference is the reference used when calculating the percent change in weight of the sample. This can be based on the initial weight of the test, the starting weight of the stage or the minimum weight during the test. Use this reference anytime you are calculating a percent weight.



## Basis

The VSA generates water activity values and corresponding sample weights during moisture desorption and resorption. To complete the isotherm, the sample weights must be translated into moisture contents. Moisture content can be calculated in different ways and reported with a variety of different units. The basis parameter allows the reporting of moisture content in two different ways, percent moisture on a wet basis and percent moisture on a dry basis.

### Percent Moisture on a Wet Basis (%wb, g/100g total)

$$\% \text{Moisture} = \frac{\text{initial weight} - \text{final weight}}{\text{initial weight}} \times 100 = \frac{\text{grams of water}}{100 \text{ grams total}}$$

### Percent Moisture on a Dry Basis (%db, g/100g solids)

$$\% \text{Moisture} = \frac{\text{initial weight} - \text{final weight}}{\text{final weight}} \times 100 = \frac{\text{grams of water}}{100 \text{ grams total}}$$

For food applications, moisture contents are reported on a wet basis. A simple equation converts between the wet and dry basis.

$$\% \text{moisture dry} = \frac{\% \text{moisture wet}}{100 - \% \text{moisture wet}} \times 100$$

$$\% \text{moisture wet} = \frac{\% \text{moisture dry}}{100 + \% \text{moisture dry}} \times 100$$

## Date

The VSA has an internal calendar and clock that allow it to record the time and date of each water activity reading. Press Enter with the Date option highlighted to set the date in the instrument. Press the left and right arrows to change between the month, day and year. Press the up or down arrows to change any of the individual values.



## Time

Pressing Enter with the Time option highlighted allows you to set the current local time. Press the up or down arrows to change any of the individual values. Press the left or right buttons to change between hour and minutes. The hour setting automatically changes between AM and PM.

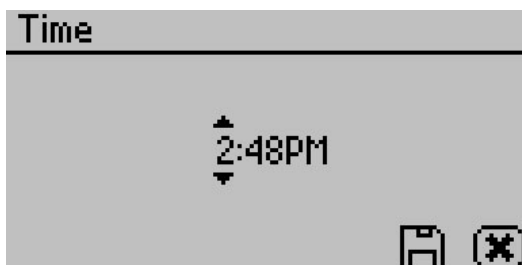

## $a_w$ Settings

Settings related to water activity measurements can be updated here. These include default system temperature, temperature equilibration tolerance and beeps.

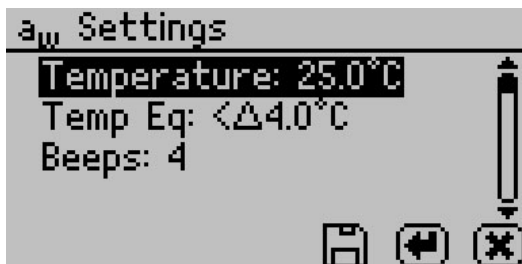

## Temperature

This setting determines the temperature that the instrument maintains during water activity measurements. It is also the temperature that the instrument returns to after completing a test. The default temperature is 25 °C. Press the Enter button to change the temperature setting. You can set the VSA anywhere between 15 and 60 °C in 0.1 °C intervals. Use the up and down arrows to set the VSA to your desired temperature.

## Temp Eq

Temperature Equilibration Tolerance or “Temp Eq” sets the maximum difference allowed between the lid and the sample. This lid to sample temperature difference must be less than the Temp Eq in order to start a water activity measurement. If a sample is out of this range, the VSA waits for the sample to equilibrate prior to beginning the water activity measurement. 4 °C is the default setting.

## Beeps

Indicates the number of audible beeps after a water activity measurement is completed. You can set this value to off (0), 4, or infinity ( $\infty$ ).

## Regional Formatting:

Allows you to configure how the VSA displays information. You may choose the temperature scale (Celsius vs Fahrenheit), the date display (mm/dd/yy vs. dd/mm/yy), the hour format (12 vs 24 hour) and the language. Press Enter to switch the setting.

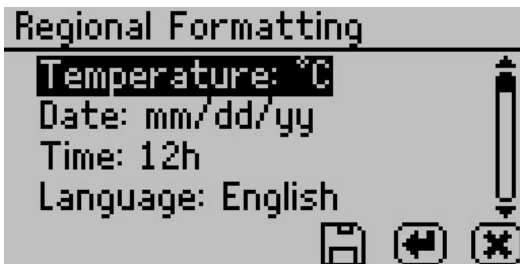

## Admin Settings

Allows you to create an administrator password as well as add, edit and delete additional users. The Admin option allows the administrator to grant or block access to some or all of the configuration options. For example, if the administrator wanted to make sure that all samples were read at 25 °C the administrator would set their temperature to 25 °C and then would lock all other users out of that Configuration screen. This is accomplished by entering the Access function and selecting the desired option to toggle it on and off. Additionally you can lock and unlock all of them at once. (For example, if you do not want an individual changing the instrument measurement temperature, the administrator can lock that function for that individual.) Administrators can lock the calibration, temperature, temperature equilibration, sensor selection, mode, date/time, region, password, auto-save, number of beeps, contrast, and delete functions.

## User Setup

Users can be added, edited or deleted from this screen. To add a user, press the Enter button with the “New” highlighted. To edit or delete a user, choose the target user and press Enter. When creating a new user, an alphabet screen appears where you can enter a name using lower case, upper case and accents.





*Note: User setup is not required for instrument operation. It is available for users wanting to be compliant with 21 CFR Part 11 or who want to maintain the settings they have selected.*

## Auto Restart

Auto restart enables the instrument to automatically resume the currently running test if there is a power failure of any kind. Press Enter to toggle auto restart between on and off. We recommend this be set to on to prevent data loss.

*Note: Restart tests with a new sample if power outages last more than 30 minutes.*

## Lighting

Turns the lighting in the desiccant tube area on or off.

## External Gas

Enables or disables the use of external gas. When External Gas is On, the external gas serves as the air source for sample desiccation and wetting. When External Gas is Off the internal pump uses ambient air as the air source.

*Note: When you use the external gas, it exhausts into the atmosphere. Be sure to provide adequate ventilation and safety measures while using an external gas supply with the instrument. Do not use combustible or hazardous gases.*

To turn external gas on, highlight “External Gas: Off” and press Enter. The External Gas screen appears.

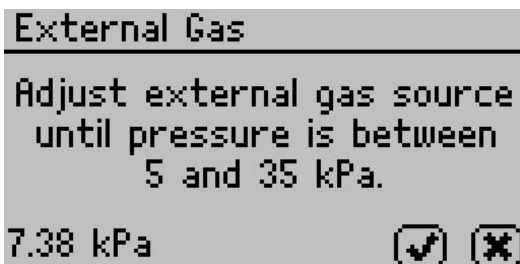

To start using external gas, remove the external gas plug from the back of the VSA and insert the desired gas source. Adjust the external gas pressure until it is between 5 and 35 kPa (0.7 to 5 psi). The VSA hides the Check Mark until the gas is within the acceptable pressure range. Press the Check Mark to enable external gas or escape to cancel.

*Note: When selecting a gas source, choose a gas supply with a filter system that eliminates oil and other particulates to help prolong the life of your VSA. Make sure to keep the external gas plug to use when you remove the external gas source.*

If the external gas is turned on in the Configuration tab and you want to turn it off, pressing enter causes the External Gas screen to appear.

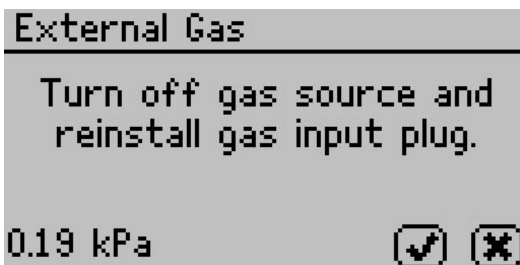

To stop using external gas, turn off the external gas source and remove the external gas tubing and adapters from the back of the instrument. Reinstall the external gas plug and then press the Check

Mark to disable external gas or the X to return to the Configuration tab without changing the setting.

### Contrast

Allows you to set the contrast of the screen to your liking. Viewing the screen from a sitting versus a standing position may require contrast adjustment for the best visibility in that position.

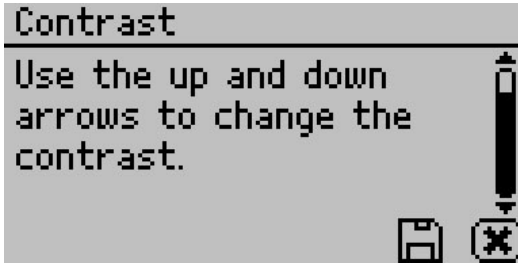

### Diagnostics

The Diagnostics screen provides you with detailed information about all the sensors in the instrument. Refer to the Troubleshooting section for details on what kind of values you should expect for each sensor. Press up or down to page between the different Diagnostics screens.

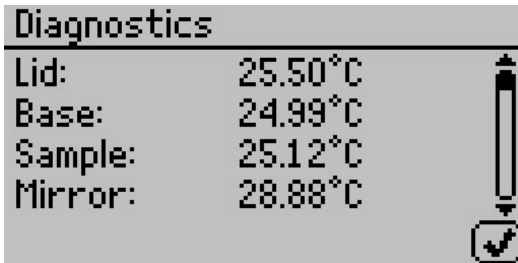

The scale icon on the bottom of the second screen allows you to zero the balance so that you can take weight readings via the diagnostic screen. The icon labeled "Act" toggles the actuator system on and off. With the lid open, pressing this button causes the weigh pan and actuator cylinder to alternatively rise and fall if working properly.

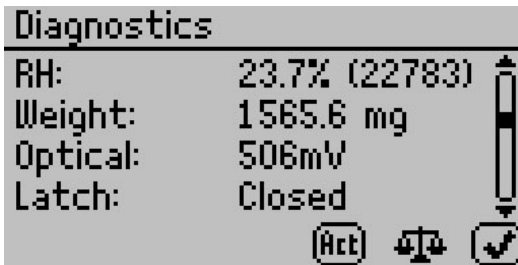

On startup, the pump is turned on and flows dry air into the chamber to monitor the desiccating capacity of the tubes. The number button on the bottom screen allows you to switch between the two desiccant tubes. If you press the number button with the arrow to the left, it switches to the left desiccant tube (#1). If you press the number button with the arrow to the right, it switches to the right desiccant tube (#2). Any time you press the desiccant tube button, the pump turns on and blows dry air into the chamber to monitor the desiccating capacity of the tubes.

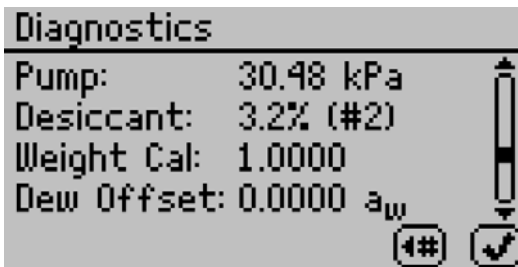

The weight calibration value is the current calibration applied to balance readings. A value of one means no weight calibration is applied. The dew point and capacitance RH sensor offset values are the current linear offsets applied to water activity readings for the respective sensor type. A value of zero means that the VSA applied no water activity offset.



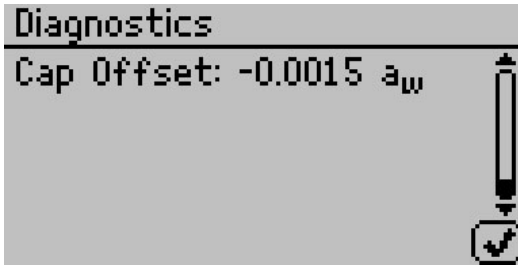

## About

The About screen provides important information including the serial number and firmware code version of your instrument.



## 5.4 Data Tab

The Data tab allows you to view detailed information about the test stored in the memory. You can view data as a list, view detailed data point information, and graph all or individual stages. You can also delete the data in the memory.

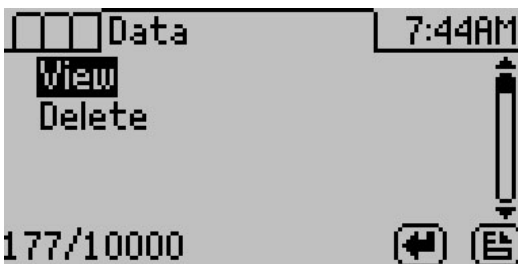

## View

This selection brings you to a screen where you can decide how you want to view your data. You can choose to view your whole test at once by selecting All or you can view an individual stage. Once the desired portion of the test is selected, you can then choose to graph the data by pressing the graph icon or by pressing the enter icon to view summary information of each data record. See Section 9 for information about downloading test data to a computer.

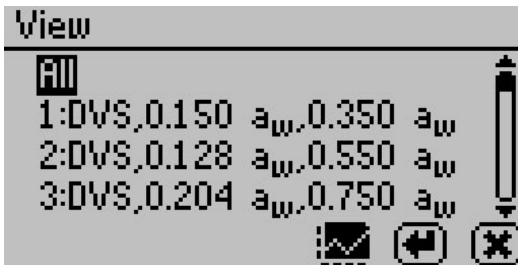

## Graph Screen

This selection shows a graph of the selected data from the previous screen. Press the directional arrows to change the y or x-axis units. The title of this graph indicates the test name, stage number (if applicable), and the isotherm type is on the right.

Example of a graph with water activity as the x-axis.

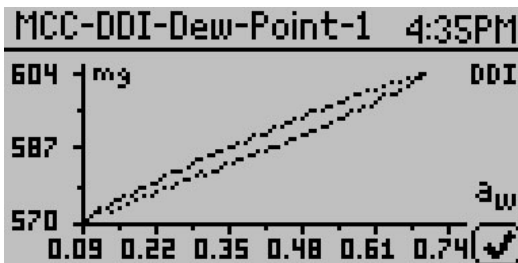

Example of a graph with elapsed time as the x-axis.

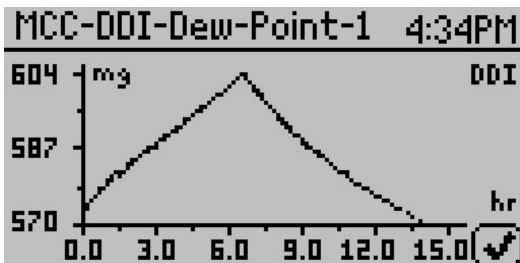

*Note: For DVS isotherms, if water activity is the x-axis, only equilibrated data points appear on the chart. To view all the data points, the x-axis must be in terms of the time elapsed.*

## Summary Screen

This selection allows you to view your stored measurements. The up/down arrows move you through the stored data with the most recent measurements at the top of the table. You may also press the left and right arrows to page quickly through the data. While on the Summary screen, press the Enter button on a highlighted reading to get detailed information on the reading in the Data screen.

Data	
0.129 $a_w$	
24.93°C	4.7 min
1322.7 mg	09/01/11
Dew Point	4:04PM
1/177	

The information shown is the water activity of the sample, the temperature, the test time, the user who ran the test (if setup), the date of the reading, the sensor used, the time of the reading, and the sequence number of the stored reading.

## Delete

Selecting this option deletes all of the information currently stored

in the instrument.

*Note: You are not able to recover deleted data so make sure you have backed up your data to the computer using the Moisture Analysis Toolkit software package prior to deleting the data from the instrument.*

## 6 Cleaning and Maintenance

### 6.1 Desiccant Cartridge Desiccant Replacement

1. Removal of the desiccant material
  - (a) Orient the desiccant cartridge or tube (Figure 10) so the lid or cap is up.
  - (b) Remove the main lid.
  - (c) Remove the foam located below the lid as shown in Figure 11.
  - (d) Hold the small tubing at the top by curling the tubing over the top edge of the cartridge. This prevents desiccant from getting into it when emptying the cartridge.
  - (e) Pour out the desiccant material.
  - (f) Wash out the lid and washer. (Figure 12) Ensure no pieces of desiccant stick to the lid and shake off any excess water.



Figure 10: Desiccant Cartridge



Figure 11: Desiccant Cartridge Foam

2. Loading the desiccant into the desiccant cartridge.

- (a) Orient the desiccant tube so the opening is upward.
- (b) Hold the tubing to the side of the cartridge and looped over the edge of the cartridge.
- (c) Fill the desiccant to the top of the cartridge.
- (d) Shake or vibrate the desiccant cartridge to settle the material.
- (e) The top of the desiccant should be about 0.1 inches from the cartridge rim. If not, add more desiccant and settle until it reaches 0.1 inches.
- (f) Place in the foam at the top.
- (g) Place the small tubing across the filter and through the slit in the foam. (Figure 11)
- (h) Wet the cartridge (bottle) lip and the edge of the washer adjacent to the bottle lip located in the lid with water as shown in Figure 12.



Figure 12: Desiccant Lid

- (i) Secure the lid to the desiccant cartridge
- (j) Verify the lid seal is correct by using the empty squeeze bottle (included with your VSA). Refer to Figure 13: Checking Desiccant Cartridge for Leaks.
  - i. Have a pan or cup with about one inch deep water in the bottom

- ii. Hold one finger over the output fitting
- iii. Pressurize the desiccant tube using the pressure bottle as shown in the figure 13.

*Note: the bottle just needs to be squeezed with air in it, do not put water into the squeeze bottle.*

- iv. Place the desiccant tube with the lid into the water. If the lid is not sealed, the water could flow into the desiccant cartridge. Hold the tube in the water only as long as needed to verify the test.
  - v. Look for bubbles escaping from the lid. A large number of bubbles indicates the lid is not sealed. You must remove the lid and reset the washer. Lubricate the washer with water and put the lid back.
- (k) When you place the desiccant cartridge into the desiccant receiver, you should wet the o-rings on the fittings for ease of installation and to reduce wear. Be sure to align the black fitting with the black ringed hole before insertion to ensure a proper seal.

AquaLab uses a 10 to 20 mesh indicating drierite as the desiccant. Indicating drierite is not required but the size of a replacement desiccant must be 10 to 20 mesh.





## 6.2 Cleaning the Testing Chamber

Keeping your VSA clean is vital to maintaining the accuracy of your instrument. Dust and sampling debris can contaminate the sampling chamber and must be regularly cleaned out.

### Purpose

The cleaning procedure removes grease, dirt and other soluble substances that can absorb or release water during verification, calibration, and sample testing. The mirror must be clean for a smooth and even dew formation. Any contaminants (e.g. fingerprints) on the mirror can cause the dew to form unevenly and affect the accuracy of the reading.

### When to Clean

The instrument should be cleaned if visual inspection indicates the chamber is dirty or as instructed in the verification flowchart. (Figure 15) We recommend cleaning before each new isotherm test.

### Required Cleaning Materials

- A thin plastic rod or other non-metal implement
- USP Purified Water
- Isopropyl Alcohol (IPA) or AquaLab Cleaning Solution
- Kimwipes®

You may also purchase the AquaLab Cleaning Kit which comes with all the above materials except the Isopropyl Alcohol. The materials in the kit should last for about one year.

### Before you begin

Cleaning your VSA is a multi-step procedure which involves washing, rinsing, and drying for each area. Section 6.3 outlines the cleaning steps.

Wash your hands with soap and water and use clean lab gloves before

starting the cleaning procedure. This prevents oils from contaminating the cleaning materials, the sample chamber and the sensors.

### Accessing the Sample Chamber

Turn the power off on your AquaLab VSA. If latched, move the lever over to the open position. Lift the chamber cover to expose the VSA sample chamber and sensors. The sample chamber consists of all surfaces within the red o-ring when the lid is closed.

Follow the cleaning procedures and do not get cleaning solution or alcohol on the capacitance sensor filter. Repeated exposure of cleaning materials or contaminants to the filter may cause inaccurate readings. If the filter appears to be contaminated, it may need to be replaced. (To replace the capacitance sensor filter, use tweezers or a small knife blade to pry up the edge of the filter, being careful not to disturb the sensor beneath. Discard the soiled filter and with clean or gloved hands press a new filter into place.)

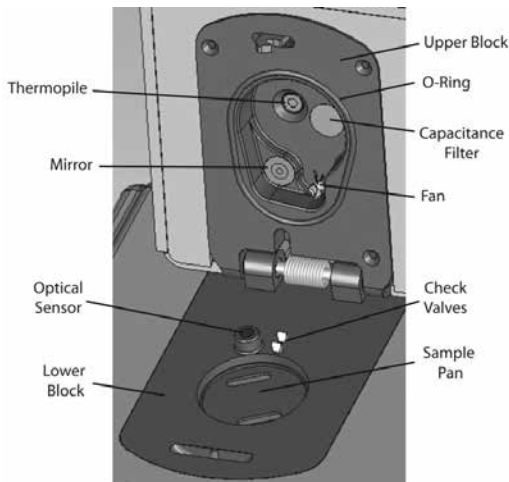

Figure 14: Sample Chamber Breakdown

### 6.3 Cleaning Procedures

Visit [www.aqualab.com/cleaning](http://www.aqualab.com/cleaning) for a cleaning video tutorial

#### 1. Cleaning the Sample Chamber

*Note: Be extremely careful not to damage the fan blades (Figure 14) when cleaning the chamber.*

- (a) Remove any debris that may have collected within or around the sample chamber.
- (b) Wrap a NEW Kimwipe around the end of the spatula (thin plastic rod) and moisten it with Decagon Cleaning Solution.

*Note: Do not dip a used Kimwipe into your cleaning solution (the cleaning solution can become contaminated).*

- (c) WASH — Clean upper chamber, o-ring, and all surfaces of the block within the o-ring. You may need to replace the Kimwipe if it becomes too dirty during this process.
- (d) Clean lower block with a fresh Kimwipe. Be sure to clean the entire block surface.
- (e) RINSE — Repeat steps b through d using new Kimwipes with USP Purified water.
- (f) DRY — Repeat steps b through d using new, dry Kimwipes to help remove any moisture remaining from the cleaning.

*Note: Do not reuse Kimwipes.*

- (g) Visually inspect the sample chamber for cleanliness. Re-clean if necessary.

#### 2. Clean the Mirror

- (a) Wrap a new Kimwipe around the end of the spatula and moisten it with Decagon Cleaning Solution.
- (b) WASH — Swipe the moistened Kimwipe across the mirror once. (A single swipe is usually sufficient to remove

contaminants.)

- (c) RINSE — Repeat steps a and b using new Kimwipes moistened with USP Purified water instead of cleaning solution.
- (d) DRY — Repeat steps a and b using a new, dry Kimwipes to help remove any moisture remaining from the cleaning.
- (e) Visually inspect the mirror for cleanliness. Clean again if necessary.

### 3. Clean the Thermopile and Optical Sensor

- (a) Wrap a new Kimwipe around the end of the spatula and moisten it with Decagon Cleaning Solution.
- (b) WASH — Swipe the moistened Kimwipe across thermopile and optical sensor. (A single swipe across the sensor is usually sufficient to remove contaminants.)
- (c) RINSE — Repeat steps a and b using new Kimwipes moistened with USP Purified water instead of cleaning solution.
- (d) DRY — Repeat steps a and b, but use a new, dry Kimwipe to help remove any moisture remaining from the cleaning.
- (e) Visually inspect the thermopile and optical sensor for cleanliness. Clean again if necessary.

### 4. Additional Drying Time

- (a) Visually inspect the sample chamber and sensors for contaminants, including moisture. If necessary, repeat the cleaning process using new Kimwipes.
- (b) Leave the chamber open for about five minutes to ensure the sample chamber is dry.

## 7 Verification of Calibration

After you have cleaned the chamber and other parts of your VSA, it is important to check the instrument performance in order to correct for any linear offset that may have occurred.

Before you check the instrument we recommend that you measure a sample of the activated charcoal pellets provided in your VSA cleaning kit from the Measurement Tab. This cleans the air inside the chamber, helping it come back to a stable sampling environment. It is important to verify VSA water activity calibration against known standards to guarantee optimal performance and accuracy. AquaLab recommends verification before running a new isotherm test.

### 7.1 Water Activity Verification

AquaLab VSA uses both a capacitance relative humidity sensor and a chilled-mirror dew point technique to determine water activity. If you set volatiles to yes as described in Section 5, the VSA performs water activity verification on the capacitance sensor only. If you set volatiles to no, the VSA verifies the dew point sensor. While the instrument does not require a routine full calibration, it is important to verify for linear offset periodically. The components used by the instrument to measure water activity are subject to contamination which may affect VSA performance. When this occurs, it changes the accuracy of the instrument. This is what is called a “linear offset.”

Therefore, frequent verification assures the VSA is performing correctly. You can check linear offset by using two different verification standards.

## 7.2 Verification Standards

Decagon's verification standards are specially prepared unsaturated salt solutions that have a specific molality and water activity value which are accurately measurable. For the most accurate verification of your VSA performance, we only recommend the verification standards manufactured by Decagon Devices.

Performance verification standards come in six water activity levels: and 0.250, 0.500, 0.760, 0.920, 0.984, and 1.000  $a_w$ . We produce these standards under a strict quality assurance regime. Please contact Decagon Devices to order additional standards or order them via the web at <http://www.aqualab.com/reorder>.

*Note: To avoid inaccurate water activity readings, verification standards should be used once immediately after opening and not stored in sample cups for repeated use.*

Table 1: Verification Flowchart

Verification Standard @ 25 °C	Water Activity
13.41 mol/kg LiCl	0.250 ±0.005
8.57 mol/kg LiCl	0.500 ±0.005
6.00 mol/kg NaCl	0.760 ±0.005
2.33 mol/kg NaCl	0.920 ±0.005

*Note: If you need to obtain a Safety Data Sheet (SDS) for any of these standards, a printable version is available on our website at <http://www.decagon.com/education/safety-data-sheets/>.*

Although distilled water and the 0.984 standard are available as a verification standard, Decagon does not recommend using them with the AquaLab VSA.

To use a verification standard, remove the twist top and pour the contents into one of the stainless steel sample cups. Customers can find information about standard values and molality printed on the outside of the plastic vial.

### 7.3 When to Verify for Linear Offset

Check the linear offset against two known verification standards before running a new isotherm test. Never verify the linear offset solely against a single standard, since it does not give an accurate representation of the linear offset. For best results, conduct the VSA water activity verification using the 0.25  $a_w$  and 0.76  $a_w$  standards. Checking the water activity of a standard solution can alert you to the possibility of unit contamination or shifts in the linear offset from other causes.

*Note: The verification process is the same whether you set the volatiles to yes or no, except that the accuracy for the capacitance sensor is  $\pm 0.020 a_w$ .*

#### Verification

Use steps 1 through 10 to verify for linear offset of your VSA. (Refer to the Measure Verification Flowchart in Figure 15)

1. From the Isotherm Tab, navigate to the Measurement tab by pressing the Enter button.
2. Choose a 0.25  $a_w$  standard.
3. Remove the weighing pan.
4. Empty a vial of solution into the stainless steel sample cup and place it in the VSA testing chamber. Make sure that your standard is as close to the instrument temperature as possible. (Section 5.2)

*Note: Make sure the rim and outside of the sample cup are clean.*

5. Carefully close the lid and move the lever to the READ position.
6. Take two readings. The water activity readings should be within  $\pm 0.005 a_w$  of the given value for the verification standard. See Appendix A for the correct water activity value of

Decagons standards at temperatures other than 25 °C.

7. If your VSA is reading within  $\pm 0.005 a_w$  of the verification standard, choose a 0.76  $a_w$  standard.
8. Prepare a sample cup of the second verification standard and make two readings. The second water activity reading for the second verification standard should be within  $\pm 0.005 a_w$ .
9. If either of the verification standards is not correct, it is probably due to contamination of the sensor chamber. See Section 6 for cleaning instructions. After cleaning, repeat verification from step two.
10. If you are consistently getting readings outside the water activity of your first verification standard by more than  $\pm 0.005 a_w$ , a linear offset has probably occurred. In this case, adjust the reading to match the correct value of the verification standards this section outlines.

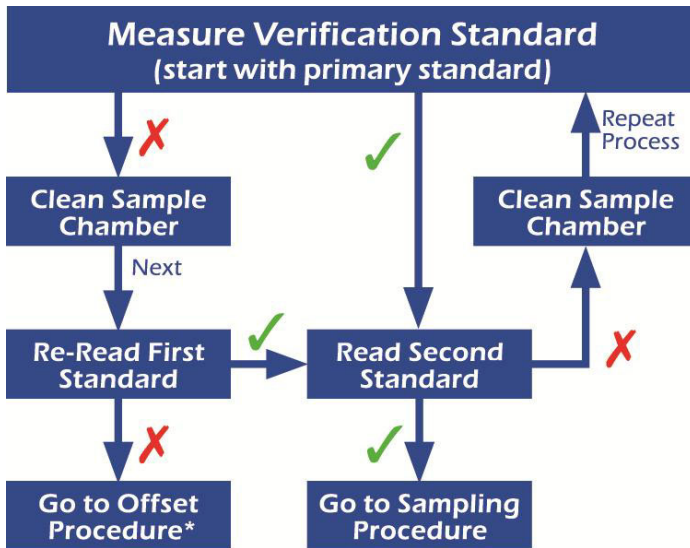

\*See the verification section in the operator's manual

Figure 15: Measure Verification Standard Flowchart



### Adjust for Linear Offset for Water Activity

1. Once you are certain a linear offset has occurred, toggle to the Configuration tab by pressing the Menu icon. Calibration is the first option highlighted in the Configuration tab. Press the Enter button to bring up the Calibration screen.

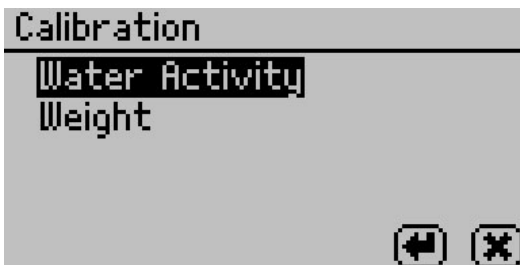

2. To offset for water activity, highlight water activity, press Enter, and the Calibration:  $a_w$  screen appears.

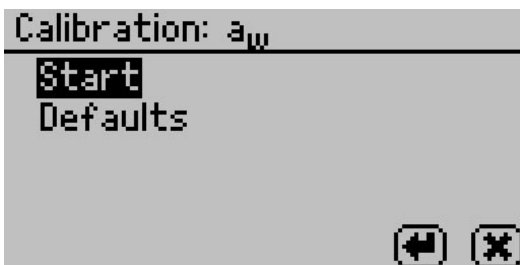

3. Highlight start and press Enter. Follow the Wizard on screen commands.
4. Empty the whole vial of solution into a sample cup. We recommend using the 6.00 molal NaCl (0.76  $a_w$ ). Do not adjust for the offset using distilled water. Ensure the rim and outside of the cup are clean. Place the sample cup in the VSA sample chamber.

*Note: You may use the same verification standard to verify and adjust the linear offset.*

5. Carefully close the lid and move the lever to the Read position.

Press the Enter button to begin testing.

*Note: If you decide at this point not to continue with the linear off set program, just return the lever to the Open position or select the X to return to the previous screen.*

6. After your VSA finishes measuring the verification standard, it displays the test value.
7. Press the up and down arrows to adjust the water activity reading to its proper value for the your particular verification standard. When the VSA displays the correct value, press Enter to store this new value. Cancel and return to the main menu to make no changes.
8. Measure the verification standard again on the Measurement Tab. It should read the proper value (within  $\pm 0.005 a_w$ ) at a given temperature for your particular standard (see Appendix A for temperatures other than 25 °C).
9. Measure the water activity of a second verification standard according to the verification procedure described above. If both verification readings are within  $\pm 0.005 a_w$  then the instrument is ready to begin testing.

If you still have incorrect verification standard readings after cleaning the chamber and adjusting for linear offset, contact AquaLab by email at [support@aqualab.com](mailto:support@aqualab.com) or by phone at 509-332-5601 for further instructions. If you purchased your AquaLab instrument from one of our international distributors, please contact them for local service and support.

## Verifying Weight Measurement

The VSA uses a magnetic force balance to gravimetrically track the weight of the sample during the isotherm test. We verify the performance of this balance against a NIST traceable two gram standard weight. This two gram weight ships with the VSA and should be handled with tweezers and not bare skin.

1. To verify the balance, toggle to the Configuration tab by pressing the Menu icon. Scroll down to Diagnostics and press the Enter button to bring up the Diagnostics Screen.

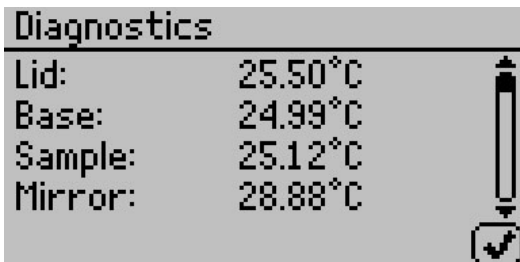

2. Scroll down until you see weight on the screen.

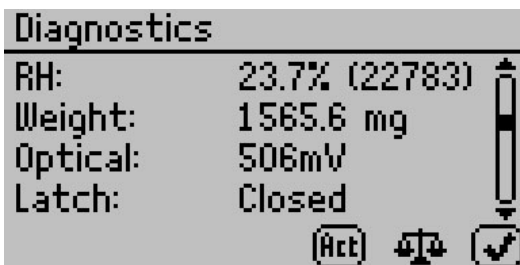

3. Close the lid and seal by pressing the lever to read.
4. Press the balance icon at the bottom to zero the balance.
5. When placing the two gram weight on the balance, handle carefully with tweezers and gloves to prevent changing the weight of the standard.
6. Close the lid and verify that the weight readings are within  $\pm 0.5$  mg of 2000 mg. If the weight reading is not correct, your instrument may require a balance adjustment.

## Adjusting for Weight Measurement Offset

1. To adjust the balance, toggle to the Configuration tab by pressing the Menu icon. Calibration is the first option highlighted

in the configuration tab. Press the Enter button to bring up the Calibration screen.

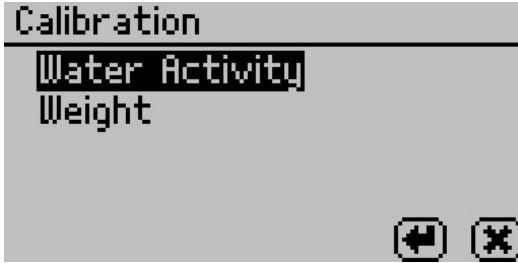

2. To adjust the balance, highlight weight, press the Enter button and the Calibration: Weight screen appears.

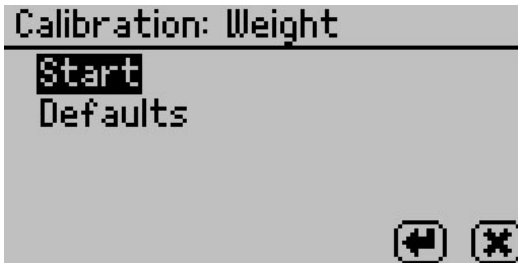

3. Highlight start and press the Enter button. Follow the wizard on screen commands.
4. When asked to place the two gram weight on the balance, handle carefully with tweezers and gloves to prevent changing the weight of the standard.
5. Carefully close the lid and move the lever to the read position. Press the Enter button to begin testing.

*Note: If you decide at this point not to continue with the linear off set program, just return the lever to the Open position or press X to return to the previous screen.*

6. After your VSA has finished measuring the weight verification, it displays the test value.

7. Press Save to adjust to the correct value. To cancel and return to the main menu, press the Cancel button and no changes be made.

If you continue to have problems with weight readings, contact AquaLab by email at support@aqualab.com or by phone at 509-332-5601 for further instructions. If you purchased your AquaLab instrument from one of our international distributors, please contact them for local service and support.

### How to Restore Factory Defaults

Follow steps 1 through 4 to restore original calibration settings

1. Toggle to the Configuration tab by pressing the Menu icon. Select Calibration and press the Enter button.
2. Select water activity or weight, depending on which defaults you want to restore and press Enter.
3. Scroll down to Defaults and press the Enter button to access the Restore Factory Defaults routine. To cancel and return to the main menu, select the Cancel icon. After selecting the Enter icon, the Calibration:  $a_w$  screen prompts you to reset to defaults.

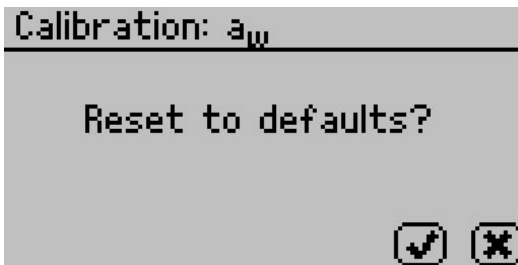

4. To restore the factory calibration values, press the Check Mark. To cancel and return to the main menu, press the Cancel button. After pressing the Check Mark, the Calibration:  $a_w$  screen verifies that VSA has restored the factory calibration.

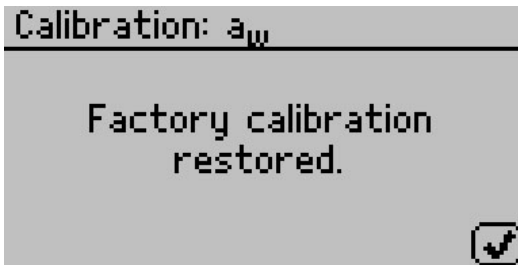

Similar screens appear if you are restoring the weight factory defaults, but the screen says weight instead of water activity. Select the Check Mark to return to the Configuration tab.

## 7.4 Isotherm Standard Comparison

If concerns arise about the accuracy of the moisture sorption curves the VSA produces, it is possible to perform a moisture sorption standard comparison. This can only be done using the Moisture Analysis Toolkit software and must be performed on Microcrystalline Cellulose (MCC). We included a sample of MCC with your instrument or you can use your own lab grade MCC. Contact AquaLab Support if you need additional MCC samples. To run an isotherm standard test, go to actions and select Run Standard Test in the software. This initiates a Test Wizard to walk you through the steps to initiate a test. The settings of this test are preset and the test takes four to five days to complete.

If the Moisture Analysis Toolkit software remains connected to the instrument throughout the duration of the standard test, the software prompts the user to save a .pdf report of the test, after which, it graphs the newly created isotherm for MCC along with a preloaded standard MCC curve to allow comparisons. To create a permanent copy of the newly created MCC curve, manually save it in the File Menu. This .pdf report contains a comparison of kinetic and moisture sorption isotherm curves, as well as an error value for the comparison of the newly created curve and the preloaded standard MCC curve. We recommend a sample size of 1 g when running the MCC standard test. An error value less than 0.12 would be acceptable. If

the error value is greater or equal to 0.12, contact AquaLab Support for additional assistance.

If you disconnect the Moisture Analysis Toolkit software at any time while running the standard test, it does not automatically generate a comparison. Instead, save the completed MCC isotherm curve as a .vsa file and then manually compare it to the preloaded standard MCC curve. To do this, select Standard Comparison from the action menu in Moisture Analysis Toolkit software to open a file dialog box. Navigate to and open the .vsa file for the MCC isotherm curve. The software outputs this curve at the conclusion of the standard test and you can compare these curves with any previously saved MCC standard isotherm curves. Doing so initiates a comparison of this curve to the preloaded standard MCC curve and the system prompts you to save a .pdf of the comparison report. Customers can use the standard comparison feature anytime to make a comparison between previously saved MCC standard isotherm curves and the preloaded MCC standard curve.

## 8 Running a Test

### 8.1 Becoming Familiar with Stages

The AquaLab VSA uses test stages to maximize the utility of running an isotherm test. In the vocabulary of setting up and running moisture sorption isotherms with the VSA, an isotherm test is considered a collection of stages all performed on one sample. Consider each stage as a unique portion of a test with its own settings while conducting all stages on one sample and combining the results into one data set at the end of the isotherm test.

Because each stage is unique, an isotherm test could consist of one stage or up to twenty stages. An example of an isotherm test with multiple stages might be running a sample through full adsorption and desorption using the static DVS method for Stage One, then setting up Stage Two to run the same test, but using the DDI method on the same sample. Another example would be to run a sample through full adsorption and desorption at 15 °C for Stage One, then, in Stage Two, switch the temperature to 25 °C and run the same test on the same sample. This stage interface makes it easy to compare dynamic and static isotherms and utilize the advantages offered by both methods all on a single sample. It also makes it easy to edit currently running tests.

### 8.2 Running a Moisture Sorption Isotherm Test

Before starting a test it is important to verify that the VSA is performing correctly using Decagon's Verification Standards. Please refer to Section 7 for instructions on how to verify your VSA and adjust the calibrations if necessary. Tests can also be setup using a Wizard interface in the Moisture Analysis Toolkit software (see Section 9 for more information).

*Note: Before starting a test, refer to Appendix B to verify you are running under non-condensing conditions, as this could void your warranty.*



1. Before starting a test, set the Volatiles: Yes/No option in the configuration menu. If your sample has volatiles, select Yes otherwise select No.
2. On the Main screen, select the Test Wizard.
3. The Warning screen appears to let the user know that any data points currently on the instrument from previous tests disappear when you begin a new test. Select the double right arrow to continue.

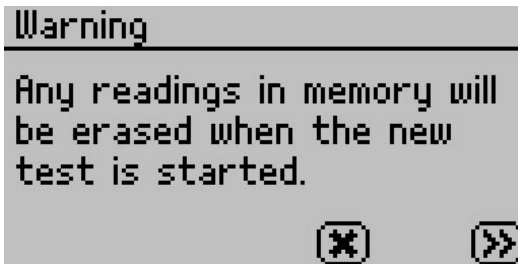

4. A new message reminding the user to make sure the water chamber is full and there is still active (blue) desiccant in the desiccant tubes. For instructions on filling the water chamber and replacing the desiccant, refer to Section 4 and Section 6 respectively. Press the double right arrow to continue or the double left arrow to go back.

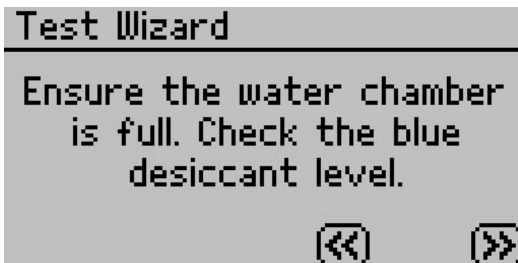

5. The Edit Test screen appears. To provide a name for the test, press the Enter button with Name highlighted and then use the arrow keys to create the name. When finished, press the Save button. (The name of a previous test appears by default.)

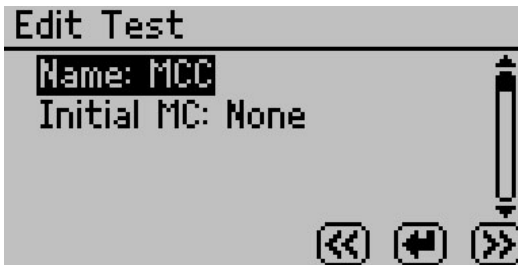

6. Enter initial moisture content if known (optional) by pressing the Enter button with Initial MC highlighted and use the up and down arrow to enter the correct moisture. The %wb refers to the moisture reporting basis, which can be either wet basis (%wb) or dry basis (%db). The moisture content basis is set as a global preference in the Configuration tab (see Section 5). Press the double right arrow to continue or the double left arrow to go back.



7. Setup each stage of the isotherm test. A stage is used to adjust the isotherm settings for an individual sample (up to 20 stages). Each stage is set up with the isotherm method (DDI or DVS) and the settings for that portion of the isotherm. Once you create a stage, you can modify or delete it anytime before you begin the test.
8. For example, for milk powder, Stage One could use the DDI method to ramp quickly from 0.1 to 0.4  $a_w$  and Stage Two could use the DVS method to step from 0.4 to 0.8  $a_w$  slowly in 0.05  $a_w$  increments.



9. To setup a new stage, select New and press the Enter button. If more than one stage is in memory, you have the option of inserting the stage after any existing stage in the test. A screen with several parameters appear. If you ran a previous test, the stages for that test list by default. You can use these stages as is or update them with new settings. If you need to delete or edit a stage, go to the specific stage, press the Enter button, and then select Edit or Delete.
10. Select the isotherm method as either DDI or DVS. DDI creates a dynamic isotherm and DVS makes a static or equilibrium isotherm. The other choices adjust according to your selected method.

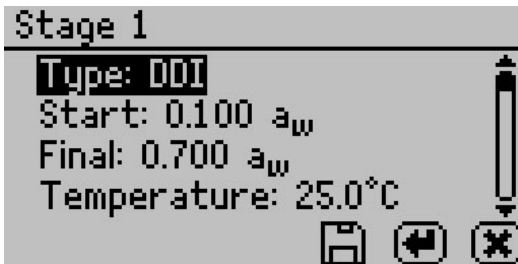

### For the DDI method

1. To choose the starting  $a_w$ , highlight “Start,” press the Enter button, and then cycle to the desired value using the up and down arrows. You can choose any value between 0.03 and 0.95  $a_w$  including current. Choosing current causes the stage to begin at the initial  $a_w$  of the sample. Press the Save button when finished.

2. To choose the final  $a_w$ , highlight “Final,” press the Enter button, and then cycle to the desired value using the up and down arrows. You can choose any value between 0.03 and 0.95  $a_w$ , including current. Selecting a final  $a_w$  that is lower than the starting  $a_w$  results in desorption, while selecting a final  $a_w$  higher than the starting  $a_w$  results in adsorption. Press the Save button when finished.
3. To choose the temperature of the stage, highlight “Temperature,” press the Enter button, and then cycle to the desired temperature using the up and down arrow keys (hold down arrows for accelerated scrolling). You can choose any temperature between 15 and 60 °C and run each stage at a unique temperature.
4. To choose the desired  $a_w$  resolution, highlight “Resolution,” press the Enter button, and then cycle to the desired value using the up and down arrows. You can choose any value between 0.003 and 1.0  $a_w$ . The resolution for DDI determines the target  $a_w$  resolution. Setting a higher step value makes the test faster, but decreases the  $a_w$  resolution. Decagon recommends a DDI step of 0.01  $a_w$ .

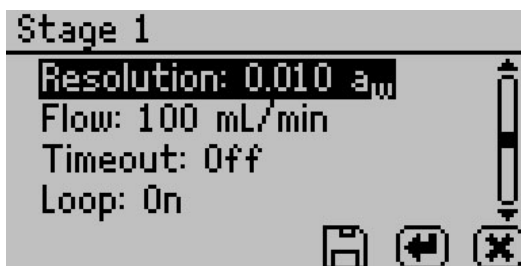

5. To choose the air flow rate, highlight “Flow,” press the Enter button, and then cycle to the desired value using the up and down arrows. You can select any value between 10 and 163 ml/min. Higher flow rates speed up the test, but may result in lower data resolution and non-equilibrium conditions. The default value of 100 ml/min is suitable for most products.
6. To choose to include a timeout setting, press the Enter button with “Timeout” highlighted, and then cycle to the desired

value using the up and down arrows. You can select any value between 5.0 minutes and 30 days. The timeout determines the maximum time allotted to move from the starting  $a_w$  to the final  $a_w$  (DDI only) and is optional. The default value is off, which means there is no timeout value.

7. To choose to have the isotherm loop, highlight “Loop” and press the Enter button to toggle between on and off. Turning loop on causes the isotherm to automatically return to the starting  $a_w$  (with the same settings) once the final  $a_w$  has been achieved. This would create both an adsorption and desorption curve (or vice versa depending on the starting direction).
8. When finished adjusting the settings for the stage, press the Save button to save and return to the Edit Stage screen. Press Cancel to return to Edit Stage screen without saving changes.

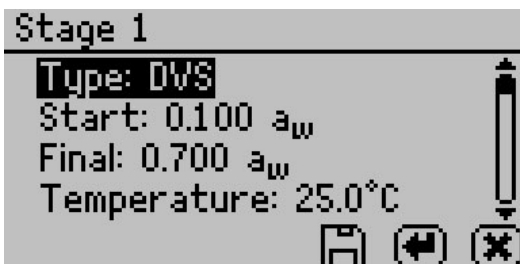

### For the DVS Method

1. To choose the starting  $a_w$ , highlight “Start,” press the Enter button, and then cycle to the desired value using the up and down arrows. You can choose any value between 0.03 and 0.95  $a_w$  including “current.” Choosing current means that the stage starts at the initial  $a_w$  of the sample. Press the Save button when finished.
2. To choose the final  $a_w$ , highlight “Final,” press the Enter button, and then cycle to the desired value using the up and down arrows. You can choose any value between 0.03 and 0.95  $a_w$  including current (see current definition above). Selecting a final  $a_w$  that is lower than the starting  $a_w$  results in desorption,

- while selecting a final  $a_w$  higher than the starting  $a_w$  results in adsorption. Press the Save button when finished.
- To choose the temperature of the stage, highlight “Temperature,” press the Enter button with “Temperature” highlighted, and then cycle to the desired temperature using the up and down arrow keys. You can choose any temperature between 15 and 60 °C and each stage can run at a unique temperature.
  - To choose the desired  $a_w$  step, highlight “Step,” press the Enter button, and then cycle to the desired value using the up and down arrows. You can choose any value between 0.003 and 1.0  $a_w$ . The step setting for DVS determines the  $a_w$  values for equilibration and consequently the resolution. A step setting of 0.10  $a_w$  with a starting value of 0.1  $a_w$  results in humidity being controlled to 0.1, 0.2, 0.3 ... up to the final  $a_w$ , remaining at each level until either equilibrium is achieved based on the trigger value or reaching the timeout value. Setting a higher value makes the test faster, but decreases the  $a_w$  resolution.

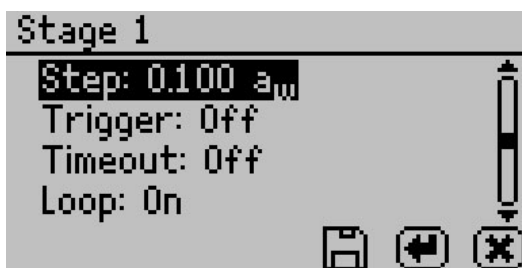

To choose the trigger %dm/dt value that indicates equilibration, highlight “Trigger,” press the Enter button to open a new window. Cycle to the desired trigger value using the up and down arrows. The trigger can be shut off or be any value between 0.001 and 1%/hr. The trigger value represents an acceptable change in mass per change in time to indicate equilibrium for a given step.

Next, choose the number of readings or events meeting the trigger value that are required to achieve equilibration. For example, choosing 3 means that in order for a step to have reached

equilibrium, three  $\%dm/dt$  readings in row must be less than the set trigger value. You can choose any value between 1 to 10. Setting a higher trigger value and a lower number of events makes the test faster, but may not result in complete equilibrium. We recommend beginning with two events at  $0.01\%/hr$ . If you turn the trigger off, the VSA holds the sample at each step for the time in the timeout setting. After adjusting all settings, press the Save button to save the settings and return to the Stage Setup screen.

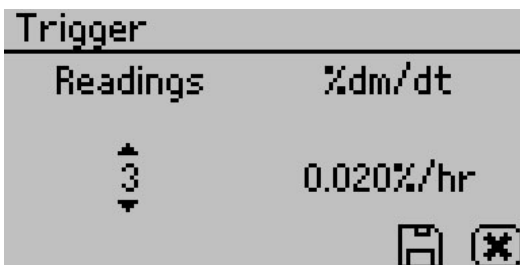

5. To choose to include a timeout setting, highlight “Timeout,” press the Enter button, and then cycle to the desired value using the up and down arrows. Any value between 5.0 min to 30 days can be selected. The timeout determines the maximum time allotted for each  $a_w$  step, not the time from starting  $a_w$  to final  $a_w$ . The default value is off, which means there is no timeout value and only the trigger value determines the end of step. If both a trigger value and timeout value are set, whichever is reached first determines the end of the step.
6. To choose to have the isotherm loop, highlight “Loop” and press the Enter button to toggle between on and off. Turning loop on causes the isotherm to automatically return to the start  $a_w$  (with the same settings) once the final  $a_w$  has been achieved. This would create both an adsorption and desorption curve (or vice versa depending on the starting direction).
7. When finished adjusting the settings for the stage, press the Save button to save and return to the Edit Stage screen. Press the Cancel button to return to Edit Stage screen without saving changes.

8. After setting up all stages on the Edit Stage screen, select the double Right arrow.
9. Follow the message on the screen to place an empty stainless steel cup in the chamber and seal it. Press the double right arrow to tare the cup.
10. Follow the message on the screen to place the sample in the cup and select the double right arrow to weigh the sample.
11. When filling the sample cup, remove the cup from the chamber to avoid spills in the chamber area.
12. Press the Enter button to begin the test.

### 8.3 Using DDI to investigate Glass Transition

To investigate glass transition events using dynamic isotherms, run a DDI test with the initial water activity set to  $0.1 a_w$ , final water activity  $> 0.80 a_w$ , flow rate of 80 to 100 ml/min, resolution of  $0.01 a_w$  and no timeout should be used.

### 8.4 Creating a Working Isotherm Using the VSA

Users can generate working isotherms using the VSA, as described in the Theory section of Section 3, though it requires several steps.

1. **Isotherm Tests:** Generate two isotherm tests using the VSA, one for adsorption and one for desorption, with both starting at the “current” water activity value. A working isotherm is an analysis of the sorption characteristics of a sample starting from its native state. Generating this data requires the analysis of two sub-samples in the same condition as the original sample.
2. **Adsorption Curve:** Analyze one sub-sample for adsorption from its current state. Set up one stage of the test with your desired settings for method (DDI or DVS), temperature, step value, flow rate etc., but the starting water activity must be “current,” and the final water activity must be a value higher than the current water activity of the sample.



3. **Desorption Curve:** Analyze a second sub-sample for desorption from its current state. The test is again setup with one stage with desired settings for method (DDI or DVS), temperature, step value, flow rate etc., but the starting water activity must be “current,” and the final water activity must be a value lower than the current water activity of the sample.

## 8.5 Editing a Running Isotherm Test

Users can edit a test that is already running by adding additional stages to a running test (inserted after the current running stage) at any time using the edit test function. This can be done using either the instrument interface or the software.

1. Press the Wizard icon as you did when starting a test. The Configure Test screen appears.

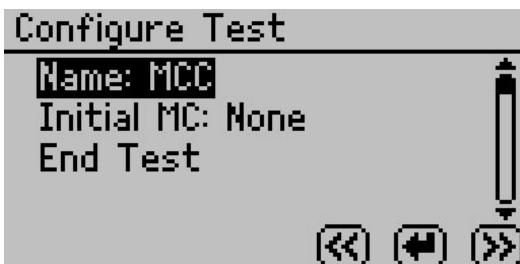

2. Press the double right arrow to edit the selected test. The Configure Stages screen appears.

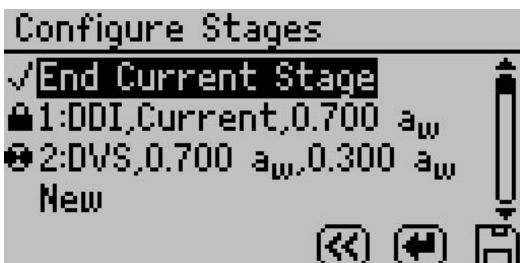

3. The current running stage (spinner icon) and completed stages (lock icons) cannot be edited. Add additional stages by se-

lecting New and pressing the Enter button. Then setup each stage as outlined above. To edit an existing stage that is not currently running and is not complete, select it and press the Enter button. Adjust the settings as instructed above.

*Note: If you do not want to end the current stage, make sure there is not a Check Mark next to “End Current Stage.”*

4. To alter a currently running stage, insert a new stage after the currently running stage. Make sure to set the starting  $a_w$  to “current” if you want the new stage to resume where the previous stage left off. Then select “End Current Stage,” press Enter to make a Check Mark appear and click the Save button. The current stage ends and the newly created stage begins.

*Note: To edit a test using the software, see the Moisture Analysis Toolkit software in Section 9.*

## 8.6 Running a Water Activity Test

*Note: The Water activity test cannot be done when the isotherm test is running*

You can also use the AquaLab VSA as a water activity meter. For best results and temperature control, we recommend you use a clean stainless steel cup for water activity testing and that you remove the weighing pan and place the cup directly on air cylinder when testing for water activity. If you set volatiles to yes as described in Section 5, the VSA determines water activity readings using the capacitance sensor, otherwise, it uses the dew point sensor.

1. From the Measurement tab, move latch left and reading starts automatically. The pinwheel spins when taking a measurement. Pressing the Enter button also starts a reading.
2. The  $a_w$  reading for the sample and the temperature displays when the VSA finishes.
3. Toggle the Volatiles Yes/No option in the Configuration menu to change between dew point and capacitive readings (Volatiles

= Yes → Capacitive Sensor, Volatiles = No → dew point Sensor).

## 9 Moisture Analysis Toolkit Software

While the AquaLab VSA can operate as a stand-alone instrument, a computer must be attached to download test results. The Moisture Analysis Toolkit software makes it easy to download moisture sorption isotherm measurements from your VSA, view the data in table or chart form, export for use in other programs, and easily setup a new test with multiple stages. After installing the Moisture Analysis Toolkit on a computer, follow these steps to utilize the software.

### Connect

1. Connect your USB cable between the VSA COM port and the USB port on your computer.
2. Open the Moisture Analysis Toolkit software.
3. Select the proper COM port in the toolbar.
4. Click the Connect button in the toolbar.

### 9.1 Configure and Start a New Test

1. Once you connect the VSA, click the Wizard button in the toolbar.
2. Follow the Wizard instructions and fill in the parameters of your test and each stage desired.
3. After completing the Wizard, follow the instructions displayed on the VSA to start your test.

### 9.2 Modify a Currently Running Test

*Note: You can only modify stages that have not yet begun. If you wish to modify the current running stage, simply create a new stage and adjust your stage behavior from the current reading of the VSA.*

1. Connect to VSA running test.
2. Click the Wizard button in the toolbar.

3. Modify stages in the currently running test.
4. Click Next.
5. Click Finish and Allow the Wizard to finish communicating with the device.

### 9.3 Download and Export

1. Once you connect the VSA after a test has been run, a download of the test starts automatically, If not, select Download in the toolbar.

*Note: It is strongly recommended to save the test (.vsa) before continuing.*

2. From the File menu or using the icon in the toolbar, select “Export” to create an Excel compatible table.
3. To view your data in table format, click the Table button in the toolbar.
4. To view your data in chart format, click the Chart button in the toolbar.

While the Moisture Analysis Toolkit does not have a User’s manual, extensive help files exist to guide you through the various features and processes of the Moisture Analysis Toolkit. To find these help files in the Moisture Analysis Toolkit, click on the Help menu item and then select the Moisture Analysis Toolkit Help submenu item to display the help files.

## 10 Sample Preparation

Proper sample preparation is an important step in keeping your VSA clean and achieving repeatable results. Careful preparation and loading of samples lengthen the time needed between cleanings and help to avoid downtime.

### 10.1 Preparing the Sample

1. Make sure the sample to be measured is homogeneous. Multi-component samples or samples that have outside coatings can be measured, but results may vary based on sample preparation methods. Some samples types need special preparation, see Section 10.2.
2. Place the sample in a stainless steel sample cup that has been tared. The sample should cover the majority of the bottom of the cup, if possible. The VSA is able to accurately measure a sample that does not or cannot cover the bottom of the cup. For example, tablets only need to be placed in the cup and not flattened or chopped to cover the bottom. A larger sample surface area increases instrument efficiency by providing more stable infrared sample temperatures and enabling better water sorption.
3. The VSA can accommodate samples of 500 to 5000 mg. Decagon recommends sample sizes of 1000 to 1500 mg. This sample size is able to give a high resolution isotherm curve without adding excessive time to the test.
4. Do not overfill the sample cup. Optimal results are obtained by having a thin layer of sample covering the bottom of the cup or a single layer of products such as tablets, pellets, or pieces. Filling the sample cup can extend test time, create layering within the sample and case-hardening, and can lead to contamination of the chamber. The volume of sample vs weight of the sample has to be optimized for each material to achieve the desired resolution and test times.

5. Do not fill the sample cup with sample while it is sitting in the chamber. The sample cup should be removed from the chamber, sample added and then placed back in the chamber to check the weight. Make sure the rim and outside of the sample cup are clean. Wipe any excess material from the cup with a clean Kimwipe. Material left on the rim or outside of the sample cup can contaminate the chamber and potentially interfere with the scale.

## 10.2 Sample Needing Special Preparation

Some samples require additional preparation to ensure accurate readings. To find out whether special sample preparation methods are necessary, multiple water activity readings should be taken to see if readings stabilize (water activity and time).

### Coated and Dried Samples

Samples with high sugar or fat coatings often take a long time to equilibrate. If this is the case for your samples, it is not a problem with the instrument; it simply means your samples take longer than most to equilibrate. To reduce the time needed to test the samples you can crush or slice the sample prior to sampling. This increases the surface area of the sample, thus decreasing reading times. However, if the effectiveness of the coating is being tested the samples should remain unchanged. Also, modifying some samples can alter the water activity readings and start point of your isotherm.

### Slow Water-Emitting Samples

Some extremely dry, dehydrated, highly viscous, water-in-oil (butter), high fat, or glassy compositions have slow water emitting properties. Tests with these materials may take longer than with other types of materials. Decagon recommends running the test as a DVS rather than DDI to ensure equilibrium is reached. DDI tests on these sample types do not reach full equilibrium and can show increased hysteresis. Sampling techniques are especially important for these sample types. The more surface area to volume the better the test

runs. Glass beads can be helpful in some instances.

### **Volatile Samples**

Samples with certain volatiles in high enough concentrations may give inaccurate water activity values when using the chilled mirror. This is because the volatiles condense on the mirror during the reading process, but do not evaporate from the mirror as water does. As a result, the reading on samples with volatiles may not be accurate. The concentration of volatiles that causes interference is variable and matrix dependent. The most effective method to determine if volatiles are a problem is to take water activity readings and compare results from the chilled mirror and capacitance sensor. Refer to Section 5 for how to take water activity readings and switching between sensors. If the dew point readings are more than 0.02 higher than the capacitance readings, volatiles are likely a problem and should be read with volatiles turned to on. Decagon designed the VSA for measuring volatiles such as propylene glycol, ethanol, and acetic acid. The VSA contains both the chilled mirror dew point and a capacitance sensor. After measuring a sample with volatiles with the capacitance sensor, it is a good idea to clean the chamber and run charcoal before switching to the dew point sensor.

### **Low Water Activity**

When a sample water activity is below the cooling capacity of the chilled mirror, the VSA displays a less than symbol or gives a low water activity message in the software. If the error persists, see the troubleshooting section.



## 11 Troubleshooting

The AquaLab VSA is a high performance and low maintenance instrument that Decagon Devices Inc. has designed to have few problems, if customers use their instrument with care and follow the proper procedures in this Operator's Manual. Unfortunately, even the best operators using the best instruments encounter technical difficulties on occasion.

Table 2 provides a quick reference table for the troubleshooting guide to direct you to detailed solutions for some of the problems that may occur with your VSA. This section lays out the most common problems and solutions for your troubleshooting needs following the quick reference table. If these remedies still do not resolve your problem, then please contact Decagon for help at [support@aqualab.com](mailto:support@aqualab.com).

When contacting support for an issue, be sure to include your contact information—Name, Title, Company, Phone Number—the instrument serial number, and a short description of your issue.

*Note: Please ensure that you read through the troubleshooting portions thoroughly before contacting Decagon for assistance.*

*Note: If you purchased your AquaLab VSA instrument from one of our international distributors, please contact them for local service and support.*

Table 2: Troubleshooting Quick Guide

<b>If this problem occurs:</b>	<b>Refer to:</b>
VSA does not turn on	Problem #1
Readings are slow or inconsistent	Problem #2
$A_w$ readings on solutions are too high/low to adjust	Problem #3
Screen displays “sample too hot”	Problem #4
Screen displays “ $a_w < 0.0$ ”	Problem #5
Dew point sensor failure	Problem #6
Verification is not correct	Problem #7
Screen displays “Crystal Failure”	Problem #8
Screen displays “Contaminated Mirror”	Problem #9
Screen displays “Firmware is corrupted”	Problem #10
Screen displays “missing bootstrap loader”	Problem #11
Screen displays “annual calibration due”	Problem #12
Screen displays “no equilibration points available!”	Problem #13
Screen displays “desiccant tube is low”	Problem #14
Displays Low or High System Pressure Warning	Problem #15
Screen displays “Power was reset”	Problem #16
Screen indicates a scale failure (overload or underload)	Problem #17
Screen displays “scale reading instability”	Problem #18
Critical error starting a test	Problem #19
Cannot communicate with the VSA	Problem #20
Weight is decreasing during adsorption	Problem #21
Weight is increasing during adsorption	Problem #22
Isotherm test has stopped prematurely	Problem #23
Isotherm test taking unusually long time to complete	Problem #24
Scale Readings are not stable or balance cannot be started	Problem #25
Scale calibration is failing	Problem #26
Desiccant cartridges are hard to install	Problem #27
Poor temperature control on the system	Problem #28
Screen displays “balance communications failure”	Problem #29

**1. PROBLEM:**

VSA does not turn on.

**SOLUTIONS:**

1. Check to make sure your power cord is securely attached to the back of the instrument and it is plugged into the power outlet.
2. A power surge may have caused a fuse to blow. To change the fuses, follow these instructions:
  - (a) Unplug the power cord.
  - (b) Locate the panel where the power cord plugs in. The fuse box is on the right side of that panel. Press in on the release tab and pull the fuse-holder out. Pull the broken fuse(s) out and replace with a 1.25 Amp 250 V fuse.

**Caution: Do not use any other kind of fuse or you risk damaging your instrument and voiding your warranty.**

- (c) Replace the fuse-holder and push it into the fuse-well until the release tab snaps in place.
- (d) Connect the power cord and turn your instrument on. If the fuse blows again, a failed component may be causing the problem. Contact Decagon to make arrangements for repairs.

**2. PROBLEM:**

Readings are slow or inconsistent.

**SOLUTIONS:**

1. The sample chamber may be dirty. Refer to Section 6 for directions on cleaning the sample chamber.
2. The temperature difference between the sample and the block chamber may be too great. The sample needs to equilibrate to instrument temperature before a fast, accurate reading can be made. (Refer to Section 8)

3. Some products absorb or desorb moisture very slowly, causing measurements to take longer than usual, and nothing can be done to speed up the process. Refer to Section 10 for further explanation.
4. Your sample may contain volatiles. Volatiles are known to cause unstable readings, because they condense on the surface of the chilled mirror and alter readings. Please refer to the volatiles section in Section 10 for hints on reducing difficulties with measuring samples with volatiles. If you have further questions regarding the measurement of volatiles contact Decagon.
5. A fan blade in the block chamber may be broken or bent. If even salt standards take a long time to read, and the sample chamber is clean, you may have a broken chamber fan blade. This is especially likely if you have just cleaned the chamber. If you suspect this may have happened, contact Decagon for details on replacement.

### **3. PROBLEM:**

Water activity readings on verification standards are too high/low and a linear offset adjustment cannot be made any higher/lower.

### **SOLUTIONS:**

1. The thermopile in your chamber, which measures sample temperature, may have become contaminated. Refer to Section 6 for directions on cleaning.
2. The chamber mirror may be dirty. Refer to Section 6 for directions on cleaning.

### **4. PROBLEM:**

Warning screen displays a message that the sample is too hot.

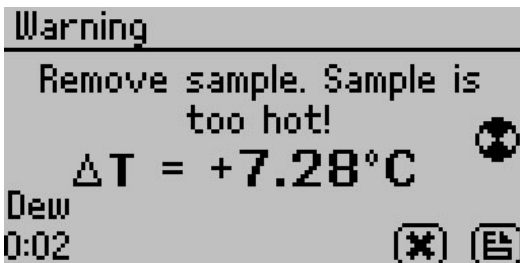
**SOLUTION:**

Your sample temperature is too high for the instrument to equilibrate with it in a reasonable amount of time. The instrument and sample need to be in temperature equilibrium to take accurate measurements. Therefore, very cold samples take a long time to measure for the same reason. To avoid this problem, make sure to only measure samples that are at the same temperature as the instrument.

**5. PROBLEM:**

Message on screen displays  $a_w$  below instrument detection limits.

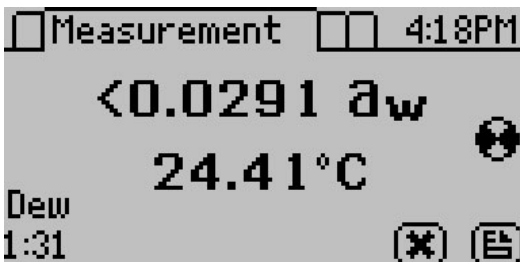
**SOLUTIONS:**

1. The sample is too dry for the instrument to read accurately. If your sample has a water activity that is below the detection limits of the instrument, this message comes up. Essentially, it means that there is not enough sample moisture to condense on the mirror and provide a reading.
2. Or the mirror may be dirty. Try cleaning the mirror and chamber and measuring the sample again.

**6. PROBLEM:**

Message on screen displaying dew point sensor failure.

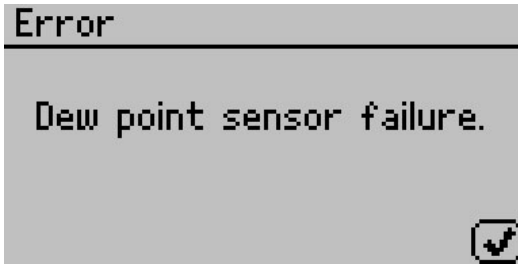
**SOLUTION:**

The cooler is damaged and needs to be serviced by Decagon. See Section 12 for detailed instructions.

**7. PROBLEM:**

Verification is not correct.

**SOLUTION:**

1. The sample chamber and mirror need to be cleaned. See Section 6 for detailed cleaning instructions. If verification is still not correct, then linear offset has occurred.
2. Verify and Adjust for Linear offset. After you have cleaned the sample chamber and mirror, use a Verification Standard to verify and adjust for Linear offset. (Section 7)

**8. PROBLEM:**

Message on screen displays “Crystal Failure”

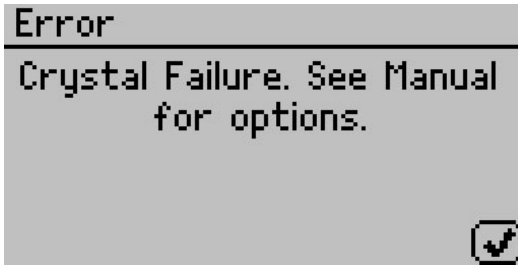
**SOLUTION:**

The crystal that runs the firmware is having trouble starting. Occasionally, cycling the power can solve this problem. If this message continues to appear, Decagon needs to service the instrument. See Section 12 for return instructions and contact information.

**9. PROBLEM:**

Message on screen displays “Contaminated mirror.”

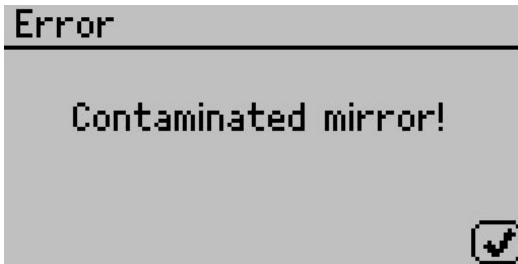
**SOLUTION:**

The mirror used for dew point measurements requires cleaning. Follow the cleaning instructions outlined in Section 6 before trying to run your sample again. If this message continues to appear, contact your Decagon Representative for further options.

**10. PROBLEM:**

Message on screen displays the error “Firmware is corrupted.”

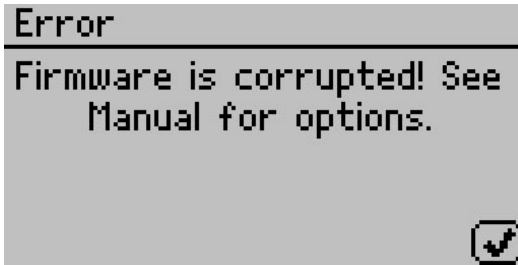
**SOLUTION:**

The firmware on the instrument is corrupted and needs to be reloaded. Contact your Decagon representative for further options.

**11. PROBLEM:**

Message on the screen displays a missing bootstrap loader error.

**SOLUTION:**

The instrument cannot download new firmware updates. To download new firmware to the VSA, or to stop this message from displaying, the instrument must be serviced by Decagon.

**12. PROBLEM:**

Message on the screen displays an annual calibration reminder.





**SOLUTION:**

This message indicates that it has been at least one year since your instrument has been calibrated and serviced by Decagon or your local distributor. Decagon service personnel recommended that you return your instrument so that we can help you ensure that you are getting the most accurate readings possible from your VSA. Click remind me later to be reminded in a couple of weeks, click do not display again if you do not want the device to remind you in the near future.

**13. PROBLEM:**

Message on screen displays no equilibration points available.

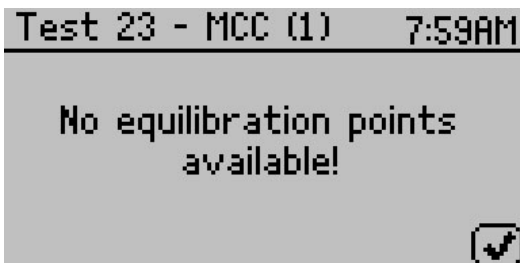
**SOLUTION:**

When graphing a test, this message indicates that there are no data points in which the weight has stabilized. The time it takes for an equilibration point to appear depends on the sample phase changes and stage trigger timeout specifications. Press the up or down arrow to view detailed data other than equilibration points.

**14. PROBLEM:**

Message on the screen indicates that a desiccant tube is low.

**SOLUTION:**

During a test, if the VSA determines that a desiccant tube has ex-

hausted its drying capacity, it automatically switches to the other desiccant tube. When this event occurs, a message appears indicating that the exhausted desiccant tube needs to be replaced. See Section 6 for information on replacing the desiccant tube.

### 15. PROBLEM:

Screen displays a Low or High System Pressure Warning.

### SOLUTION:

Anytime the VSA instrument requires air flow, it monitors the system pressure and sends a warning if the system pressure is outside the expected range for the current scenario. This may be caused by one of several issues.

1. External gas flowing when the external gas setting is off.
2. External gas not flowing when external gas setting is on.
3. External gas pressure outside the recommended range for running a test.
4. External gas input plug not properly installed or missing when external gas is off.
5. Both desiccant tubes not properly installed or missing.
6. Water chamber plug not properly installed or missing.
7. Pump system failing.

If you continue to receive a message after the above items have been checked, contact your Decagon representative for further options.

### 16. PROBLEM:

Screen displays “Power was reset.”

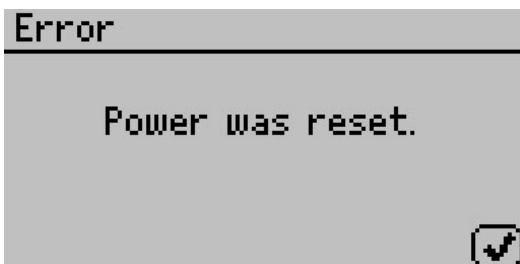

**SOLUTION:**

If the VSA instrument resets because of a power outage at any-time during a test or due to unforeseen circumstances, this message appears on the screen. If Auto Restart is turned on, the test automatically resumes after a device reset. If Auto Restart is turned off, then the test stops running following a device reset. To prevent device resets, Decagon strongly recommends that you connect your VSA to an Uninterruptible Power Supply (UPS).

**17. PROBLEM:**

Screen indicates a scale failure, overload or underload.

**SOLUTION:**

If the VSA is unable to communicate with the scale, the scale failure message appears. If the scale is reading overload or underload, then the balance is either misaligned or broken. If any of these instances occur Decagon needs to service your VSA.

**18. PROBLEM:**

Screen displays “Scale Reading Instability”

**SOLUTION:**

A Scale Reading Instability issue occurs when the balance is unable to read stable readings from the balance. This may be caused by a dirty chamber, a faulty or damaged air cylinder, a misaligned scale shaft or a pump assembly problem. Clean the chamber including the air cylinder, the weighing pan, and the space beneath the air cylinder. If you continue to have problems, contact your Decagon Devices representative.

**19. PROBLEM:**

Message on the screen displays a critical error while starting the test.

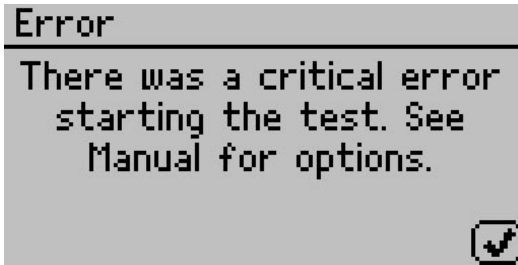
**SOLUTION:**

Verify that the following three items before starting a test.

1. The sample weight is at least 50 milligrams.
2. The test must have a name.
3. The test must contain at least one stage.

If you continue to receive this error, contact Decagon.

**20. PROBLEM:**

Cannot communicate with the VSA.

**SOLUTIONS:**

1. USB cable not plugged in to power.
2. Wrong com port selected.
3. Restart VSA.
4. Restart communication software.

**21. PROBLEM:**

Weight is decreasing during absorption.

**SOLUTIONS:**

1. Water tank has run dry.
2. Plug on water fill tank loose.
3. Pump is not working.
4. Material is undergoing a phase change.
5. Scale needs to be checked for calibration.

**22. PROBLEM:**

Weight is increasing during desorption.

**SOLUTIONS:**

1. Desiccant cartridge has been used up.
2. Pump is not working.
3. Desiccant tube/tubes leaking.
4. Scale needs to be checked for calibration.

**23. PROBLEM:**

Isotherm test has stopped prematurely.

**SOLUTIONS:**

1. Download the test with the Moisture Analysis Toolkit.
2. Navigate to the Table view.
3. Scroll down to the last data record in the list.
4. Look in the special condition column to see what caused the test to stop prematurely.
5. Refer to the troubleshooting section that references the special condition indicated.

**24. PROBLEM:**

Isotherm test is taking an unusually long time to complete, even at high flow rates.

**SOLUTIONS:**

1. Sample has very slow sorption properties.
2. Increase the flow rate.
3. Water tank has run dry.
4. Desiccant cartridge has been used up.

**25. PROBLEM:**

Scale readings are not stable or the sample cups cannot be tared.

**SOLUTIONS:**

1. Unstable bench or support for the VSA.
2. Air cylinder internal parts need to be cleaned. Lift out air cylinder and clean.
3. Interior parts have shifted and are contacting so air cylinder does not slide.
4. Verify actuation using ACT Button in diagnostics as described in Section 5.

**26. PROBLEM:**

Scale calibration is failing.

**SOLUTIONS:**

1. Air cylinder and internal parts need to be cleaned.
2. Air cylinder is not actuating. May be sticking due to contamination in chamber.

**27. PROBLEM:**

Desiccant cartridges hard to install.

**SOLUTIONS:**

Dampen the o-rings on the desiccant cartridge using water before installing.

**28. PROBLEM:**

Poor temperature control on the system.

**SOLUTIONS:**

1. Clean the filters on the enclosure fans.
2. Check that external fan on the back of the unit is operational.

**29. PROBLEM:**

Screen Displays: “Balance Communication Failure.”

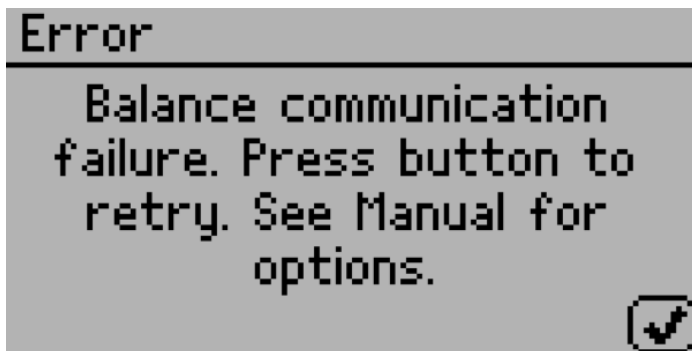

Figure 16

**SOLUTIONS:**

1. Press the check button to retry the balance communication.
2. Try cycling the power on the instrument.
3. If you continue to have problems, please contact your Decagon representative.

**11.1 Diagnostics Screen**

If, after cleaning your instrument and reading the other troubleshooting hints, you have reason to believe that one of the components of your VSA may be causing measurement error, you may access a screen that displays values for component performance. Navigate to the Configuration tab and then scroll down to the Diagnostics option. Press Enter to open a list of components and their values.

This screen shows typical values for the temperature sensors on the instrument. Press up and down to scroll between the different pages. Lid, base and sample temperatures may fluctuate but should not change more than 0.03 °C. Typical ranges for the lid, base and sample temperatures are between 24.5 and 25.5 °C, when unit temperature is set to 25 °C.

If the mirror temperature is at lid temperature, the cooler has failed and must be replaced. If the mirror is below the lid temperature or appears to be random, the thermocouple wire is broken and must be repaired. If the lid temperature is much higher than the set temperature, the lid fan may have failed and must be replaced.

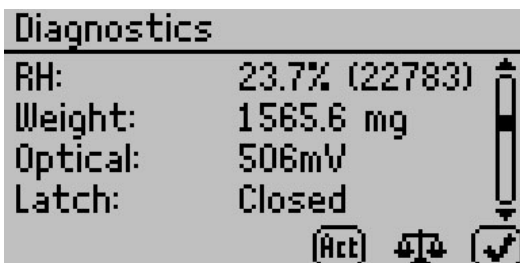

**RH:** This screen shows the capacitive sensor RH percentage which should always be between 0 and 100%.

**Weight:** The weight measurement updates in real-time and can be zeroed for measurements by pressing the scale icon (2nd button from the left). If the weight reads overload or underload, the balance is broken and needs to be replaced. A negative value indicates that the balance needs to be re-zeroed if you want to take weight measurements.

**Optical:** A typical optical range is between 500 mV and 2900 mV.

**Latch:** To determine if the latch is functioning properly, open and close the latch while monitoring the latch status on the screen. If the screen does not update the latch status when you open and close the latch, the latch magnet may need to be re-seated (with the correct polarity) or the Hall Effect sensor needs to be realigned with the magnet.

**Actuator:** The Act button toggles the actuator on and off, lifting the sample pan up and down to confirm the actuator functions properly. Use this button to verify that the actuator works correctly and that it is not throwing off weight readings. Occasionally contaminants or defects can cause the cylinder to stick and prevent accurate



weight measurements. The Act button is an easy way to verify the actuator function.

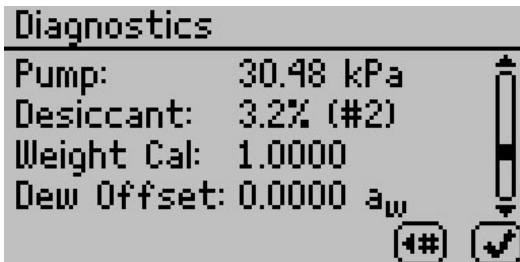

**Pump:** The pump pressure is only valid when the pump is active. When the pump is off, the pressure should be between 0 and 0.7 kPa. This pressure reading also applies to an auxiliary air supply. When the air supply is active the pressure in the system should not exceed 52 kPa. If the pump pressure continually reads zero (even when you press the switch desiccant button) then the pump system may need to be serviced.

**Desiccant:** The desiccant humidity value indicates the effectiveness of the desiccant tubes. Initially when the diagnostic screen is turned on, the pump supplies flow through the active desiccant tube to help verify that it can desiccate properly. After 30 seconds of pumping, the desiccant humidity reading should be 5% or less. If the desiccant humidity is unable to reach 5% humidity, refer to Section 6 for instructions on replacing the desiccant tubes.

**Weight Cal:** The weight calibration saved a scalar into memory that applies to all subsequent weight readings. A scalar of 1 means that the weight has not been changed from the default factory calibration. If the scalar strays too far from 1, you may need to reverify the balance and also certify the weight standard again.

**Dew Offset:** The chilled mirror dew point calibration offset is zero if it is running off of the default factory calibration. This value indicates the offset the instrument applies to the water activity readings for accurate readings.

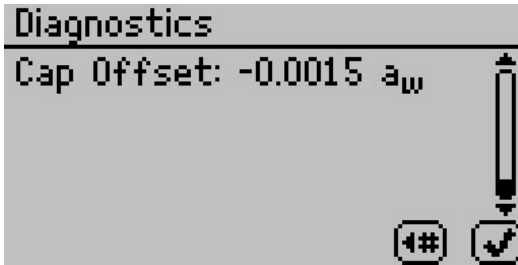

**Cap Offset:** The capacitive RH calibration offset is zero if the VSA is running off of the default factory calibration. This value indicates the offset the instrument applies to the water activity readings for accurate readings.

## 12 Support and Repair

*Note: If you purchased your AquaLab from one of our international distributors, please contact them. They can provide you with local support and service.*

When encountering problems with your VSA (that you are unable to resolve with the help of this manual), please contact Decagon Customer Support at support@aqualab.com, 509-332-5601 or fax us at 509-332-5158. Please have the serial number and model of the instrument ready.

AquaLab annual calibration is available. For details on sending your AquaLab to Decagon or your distributor for calibration, contact us by phone or email at support@aqualab.com.

All instruments returning to Decagon for servicing must be accompanied with a Return Material Authorization (RMA) number. Prior to shipping the instrument, please contact a Decagon customer support representative to obtain an RMA number.

### Shipping Directions

The following steps should help to ensure the safe shipping and processing of your VSA.

1. Ship the VSA in its original cardboard box with foam insert. Failure to ship in proper packaging can damage the scale and void the warranty.
2. Do not ship the power cord or serial cable and be sure the water tank is empty.
3. Remove the desiccant tubes and wrap them in bubble wrap to include with your VSA.
4. Remove the weight pan and air cylinder, wrap both separately to prevent damage.
5. On the RMA form, please verify the ship to and bill to information, contact name, and problem description. If anything is

incorrect please contact a Decagon representative.

6. Tape the box in both directions for added support.
7. Include the RMA number in the attention line on the shipping label.

**Ship to:**

Decagon Devices Inc.

ATTN: RMA (insert your RMA #)

2365 NE Hopkins Court

Pullman, WA 99163

## 12.1 Repair Costs

Decagon Devices repairs manufacturer defects and instruments within the one year warranty at no charge. We charge you for non-warranty repairs based on cost of parts, labor and shipping. An extra fee may be charged for rush work. Decagon can provide an estimated repair cost upon request.

## 13 Appendix A

### Temperature Correction of Decagon's Verification Standards

Table 3: Water Activity of Selected Solutions

Temp. (°C)	H <sub>2</sub> O	0.50 mol/kg KCL	2.33 mol/kg NaCL	6.00 mol/kg NaCL	8.57 mol/kg LiCl	13.41 mol/kg LiCl
10.0	1.000	0.984	0.923	0.762	0.491	0.234
15.0	1.000	0.984	0.923	0.761	0.492	0.238
20.0	1.000	0.984	0.922	0.760	0.496	0.245
25.0	1.000	0.984	0.920	0.760	0.500	0.250
30.0	1.000	0.984	0.920	0.760	0.504	0.255
35.0	1.000	0.984	0.920	0.760	0.508	0.261
40.0	1.000	0.984	0.921	0.760	0.512	0.266
50.0	1.000	0.984	0.894	0.740	0.517	0.275
60.0	1.000	0.984	0.894	0.740	0.505	0.279

*Note: The AquaLab VSA measures these verification standards to  $\pm 0.005 a_w$ ,  $\pm 0.02$  with volatiles on yes.*

## 14 Appendix B

### Non-Condensing Conditions for VSA Testing

Non-Condensing Ambient Humidity Limit for Test Temperatures Below 25°C					
Ambient Temperature (°C)	15°C Test	17°C Test	20°C Test	23°C Test	25°C Test
16.0	93.8	100.0	100.0	100.0	100.0
17.0	88.0	100.0	100.0	100.0	100.0
18.0	82.6	93.9	100.0	100.0	100.0
19.0	77.6	88.2	100.0	100.0	100.0
20.0	72.9	82.9	100.0	100.0	100.0
21.0	68.6	77.9	94.0	100.0	100.0
22.0	64.5	73.3	88.4	100.0	100.0
23.0	60.7	69.0	83.2	100.0	100.0
24.0	57.1	64.9	78.4	94.1	100.0
25.0	53.8	61.2	73.8	88.7	100.0
26.0	50.7	57.6	69.5	83.6	94.2
27.0	47.8	54.3	65.6	78.8	88.8
28.0	45.1	51.2	61.8	74.3	83.8
29.0	42.6	48.4	58.3	70.1	79.1
30.0	40.2	45.6	55.1	66.2	74.6
31.0	37.9	43.1	52.0	62.5	70.5
32.0	35.8	40.7	49.1	59.1	66.6
33.0	33.9	38.5	46.4	55.8	62.9
34.0	32.0	36.4	43.9	52.8	59.5
35.0	30.3	34.4	41.5	49.9	56.3
36.0	28.7	32.6	39.3	47.2	53.3
37.0	27.1	30.8	37.2	44.7	50.4
38.0	25.7	29.2	35.2	42.4	47.8
39.0	24.4	27.7	33.4	40.1	45.3
40.0	23.1	26.2	31.7	38.0	42.9

This table shows the maximum advisable ambient humidity levels for the ambient room and test temperatures. Staying within these limits prevents condensation in and on the VSA. Operating in humidity and temperature conditions beyond these limits voids the VSA warranty and can damage the instrument. Please contact us if you have any questions or require any additional assistance.

## 15 Declaration of Conformity

Application of Council Directive: 2004/108/EC and 2011/65/EU

Standards to which conformity is declared: EN 61326-1:2013 and  
EN 50581:2012

Manufacturer's Name: Decagon Devices, Inc 2365 NE  
Hopkins Ct. Pullman, WA 99163  
USA

Type of Equipment: AquaLab Vapor Sorption Ana-  
lyzer

Model Number: VSA

Year of First Manufacture: 2011

The undersigned hereby declares on behalf of Decagon Devices, Inc. that the above referenced products, to which this declaration relates, fully conform to the provisions of the Council Directives and standards referenced above.



Michael Wadsworth  
Engineering Director  
7-9-2015

## 16 Certificate of Traceability

Decagon Devices, Inc.  
2365 NE Hopkins Court  
Pullman WA 99163 USA

Tel: 509-332-5601  
Fax: 509-332-5158  
support@Aqualab.com

Decagon Inc. manufactures the VSA according to temperature standards with calibration traceable to the National Institute of Standards and Technology (NIST).



# Index

- Annual Calibration Service, 95
- Aqualab VSA Information, 5
- Balance Magnetic Force, 54
- Calibration, 27
  - Verification of, 49
- Certificate of Traceability, 100
- Cleaning Procedures, 47
  - Block and Sensors, 46
  - Testing Chamber, 45
- Components, VSA, 20
- Configuration Tab, 26, 53
- Customer Support, 1, 95
- Data Tab, 37
- Declaration of Conformity, 99
- Desiccant Cartridge
  - Replacement, 41
- Desorption, 10
- Diagnostics, 35
- Dynamic Dew Point Isotherm (DDI), 63
- Dynamic Vapor Sorption (DVS), 62, 65
- Email, 1, 95, 100
- Equilibrium Isotherms, 1, 5, 9
- External Gas, 6, 33
- Flow Rate, Air, 64, 89
- Fuse, 79
- Glass Transition, 5, 10, 19, 68
- Hysteresis, 11, 17
- Isotherm
  - Models, 16
  - Moisture Sorption, 8
    - Types, 8
  - Isotherm Tab, 25
  - Linear Offset, 49
  - Matrix Changes, 1, 13
  - Measurement Tab, 25
  - Microcrystalline Cellulose (MCC), 58
  - Moisture Analysis Toolkit, 72
  - Moisture Content
    - Basis, 28
  - Moisture Sorption Isotherm
    - Moisture Sorption, 4
    - Test, 60
  - Power Outage, 87
  - Product Development, 18
  - Salt Standard, 50
  - Sample Prep
    - Coated and Dried, 75
    - Low Water Activity, 76
    - Preparation, 74
    - Slow Water Emitting, 75
    - Volatiles, 76
  - Sample Preparation, 74
  - Seller's Liability, 2
  - Setup
    - Instrument, 21
  - Shelf Life Prediction, 18
  - Specifications, 6
  - Stages, 60
  - Standards, 50, 97
  - Static Isotherms, 60

Tabs, 25  
Tare, 68  
Temperature Control Range, 7  
Test Wizard, 61  
Theory, 8  
Trigger, 66  
Troubleshooting, 77

User Interface, 25

Vapor Equilibrium, 10  
Verification Standards, 49  
Volatiles, 28, 80

Warranty, 2, 96  
Water Activity  
    Accuracy, 6  
    Range, 6  
    Repeatability, 6  
    Resolution, 6  
    Testing, 70  
Water Tank, 23  
Weight Reference, 28  
Working Isotherm, 68